

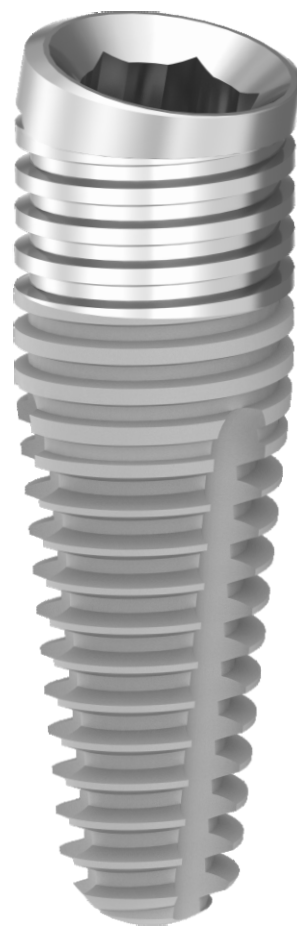

SOUTHERNIMPLANTS®

Innovative Treatment Solutions

PROVATA® Implants
Product Catalogue





Southern Implants® is a leading provider of unique and innovative dental implant products with a focus on top-end professional users who want more choices. Southern's expertise in research, development and manufacturing of dental implants allows us to provide Innovative Treatment Solutions that will reduce treatment times and improve patient outcomes.

Striving for excellence and meeting customer needs, has led to our wide product range characterised by Unique and Innovative products which include:

- Multiple interfaces, to suit customer preference.
- INVERTA® implant, featuring a Body-Shift™ design, engineered for primary stability and suitable for immediate loading.
- Co-Axis®, Subcrestal Angle Correction® implants, available in angulations of 12°, 24° and 36° and various internal and external connections.
- MAX implant, specifically designed for immediate molar tooth replacement.
- The ZYGAN® and ZYGEX implants for severely resorbed maxilla and craniofacial reconstruction.

Our product portfolio is in synchronised evolution with protocol improvements and technological advances.

My sincere thanks to all specialists, dentists and technicians who put their trust in our company.

Graham Blackbeard
Managing Director, Southern Implants

CONTENTS

● Ø3.3 mm Implants (Tapered)	
Implants and Surgical Components.....	Page 06
Prosthetic Flowchart.....	Page 07
Site Preparation Sequence.....	Page 08
● Ø4.0 mm Implants (Tapered)	
Implants and Surgical Components.....	Page 10
Prosthetic Flowchart.....	Page 11
Site Preparation Sequence.....	Page 12
● PROVATA® Ø5.0 mm / PROMAX® Ø6.0 mm Implants (Tapered)	
Implants and Surgical Components.....	Page 14
Prosthetic Flowchart.....	Page 15
● Platform Matched Prosthetic Flowchart	Page 16
The Platform Matched Prosthetic Approach.....	Page 17
Site Preparation Sequence.....	Page 18
● PROVATA® Ø6.0 mm Implants (Tapered)	
PROMAX® Ø7.0 mm / Ø8.0 mm / Ø9.0 mm Implants (Tapered)	
Implants and Surgical Components.....	Page 20
Prosthetic Flowchart.....	Page 21
Site Preparation Sequence.....	Page 22
SFT-PRO3 Multipurpose Fixture Mount/Scan Flag/Impression Coping.....	Page 24
Instrument Trays	
I-HEX-EG.....	Page 26
I-MAX-EG.....	Page 28
I-PROS-EG.....	Page 30
Torque Table for Southern Screws.....	Page 31
MSC Implants Explained.....	Page 32
Drill Information.....	Page 32
Insertion Tool Protocol.....	Page 32
Insertion Tool Depth Markings.....	Page 33
Co-Axis® Fixture Mount Removal Protocol.....	Page 33
Implant Dimensions and Information.....	Page 34
Explanation of Symbols.....	Page 35

For more information scan the below



or visit

SOUTHERNIMPLANTS.COM

NOTE:

- images are for illustration purposes only and do not necessarily accurately represent the product.
- all dimensions in this catalogue are in mm, unless otherwise specified.
- not all products are cleared for sale in all countries.

PROVATA®

Ø3.3 mm

 Restore with narrow interface components

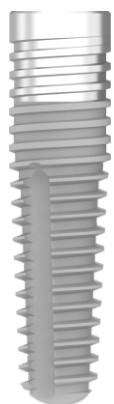

MSC-PRO3xx

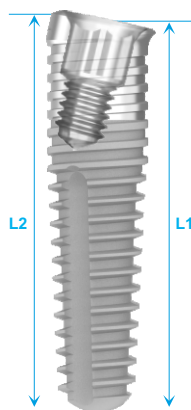

MSC-PRO12D3xx

(where xx is implant length)

Implants are available in lengths of:

NOTE: implant dimensions and information - page 34.

ITEM CODE MSC-TAPERED (with fixture mount)	MSC-TAPERED (without fixture mount)	IMPLANT LENGTHS (in mm)
MSC-PRO308	MSC-PRO308NF	8.5
MSC-PRO310	MSC-PRO310NF	10
MSC-PRO311	MSC-PRO311NF	11.5
MSC-PRO313	MSC-PRO313NF	13
MSC-PRO315	MSC-PRO315NF	15
MSC-PRO318	MSC-PRO318NF	18



ITEM CODE MSC-TAPERED (with standard fixture mount)	IMPLANT LENGTHS (in mm)	
	L1	L2
MSC-PRO12D308	8.5	8.8
MSC-PRO12D310	10	10.3
MSC-PRO12D311	11.5	11.8
MSC-PRO12D313	13	13.3
MSC-PRO12D315	15	15.3
MSC-PRO12D318	18	18.3

'NF' in the item code denotes that the implant is packaged without a multipurpose fixture mount.

NOTE: all Co-Axis® implants are packaged with a fixture mount.

- NOTE:**
- there are dedicated insertion tools (i.e. I-H3M-M/L or I-WI-3M-S/M/L) should the user wish to place a regular PRO3 implant without a fixture mount.
 - the standard insertion tools (I-HM-GS, I-HM-M/L or I-WI-M-S/M/L) are to be used at fixture mount-level for both the regular and Co-Axis® PRO3 implants.
 - refer to CAT-1212 and page 24 for additional information regarding the multipurpose fixture mount.

Surgical Components

Cover Screw

Healing Abutments

CS-3M



HA-3M-35



3/4/6 lengths

HA-3M-45



3/4/6 lengths

Prosthetic Flowchart

Direct

Healing Abutments

HA-3M-35



3/4/6

HA-3M-45



3/4/6

Multipurpose Impression Coping and Scan Flag

SFT-PRO3



The SFT-PRO3 is packaged with both a retaining screw (TS-Z-16) and an impression coping pin, depending on the clinician's preference for impression taking (pick-up, transfer or via scanning).

OPTION 1:
Used as a PICK-UP IMPRESSION COPING



Use with impression coping pin

OPTION 2:
Used as a TRANSFER IMPRESSION COPING OR SCAN FLAG



Use with TS-Z-16.

Refer to CAT-1212 and page 24 for additional information regarding the multipurpose fixture mount.

LA-3M

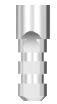

LAD-3M



(digital analogue)

Prosthetic Components

TC-3M (engaging)
TC-3NM (non-engaging)



Titanium

TEMPORARY Abutments

PKR-3M-2 (engaging)
PKR-3NM-2 (non-engaging)



PEEK*

*Screw torque: 15 Ncm

TIBS-3M-C1.5
TIBS-3M-C3 (engaging)



TIB abutments available in 2 cuff height variants: 1.5 mm and 3 mm

SCANNABLE Abutments

PASSIVE Abutments

PA-3EM-S (engaging)
PA-3NM-S (non-engaging)



Passive Abutment Screws

PA-M-16T



Titanium (1.27 Hex)

TORQUE: 32 Ncm

PA-M-16B*



Brass (1.27 Hex)

* (Blackened and for laboratory use only)

TORQUE: 32 Ncm

Retaining Screws

TS-Z-16



Titanium (1.27 Hex)

TORQUE: 32 Ncm

BS-Z-16*



Brass (1.27 Hex)

* (Blackened and for laboratory use only)

INDIRECT

Compact Conical Abutments

MC-3M



1/3/5

MC-3M-20d*



* Packed with TS-Z-MC-16

HMC



4/6

OR

HMCT7



4/6

CMC1 (pick-up)



CMC2 (transfer)



CMC-ZG-2 (transfer)



SFT-MC-48 (scanning flag)



Titanium

LSMC1



LAD-MC



(digital analogue)

GMC1



Gold

TMC1 / 5



Titanium
TMCSL (long version)

PKC-MC



PEEK*
*Screw torque: 10 - 15 Ncm

PA-MC-48 (passive abutment)



1 Series Screws

TORQUE: 10 - 15 Ncm

Site Preparation Sequence

Ø3.3 mm (MSC-PRO3xx)

(illustrations are for 13 mm implants)

Soft Bone

D-3Spode-1.8M
Ø2.0 mm
Ø3.0 mm

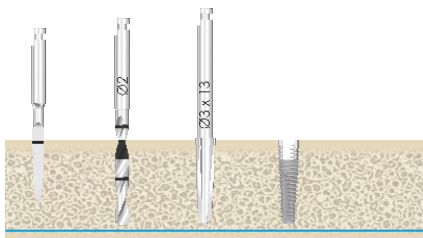

Medium Bone

D-3Spode-1.8M
Ø2.0 mm
Ø3.3 mm

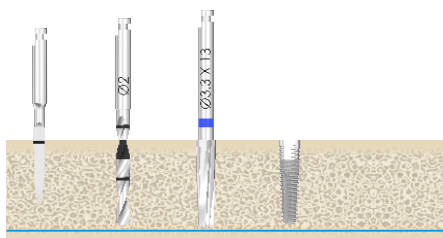

Dense Bone

D-3Spode-1.8M
Ø2.0 mm
Ø3.3 mm
D-TAP-IBNT

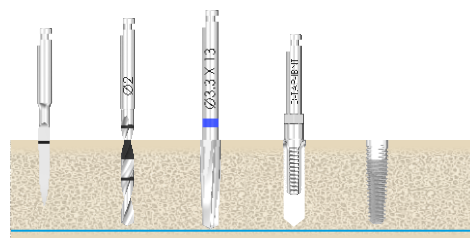

Ø3.3 mm Co-Axis® (MSC-PRO12D3xx)

Soft Bone

D-3Spode-1.8M
Ø2.0 mm
Ø3.0 mm

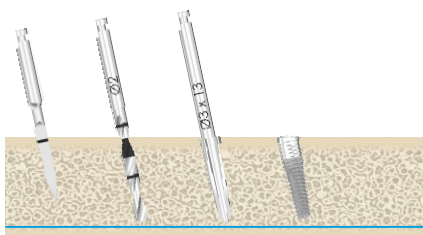

Medium Bone

D-3Spode-1.8M
Ø2.0 mm
Ø3.3 mm

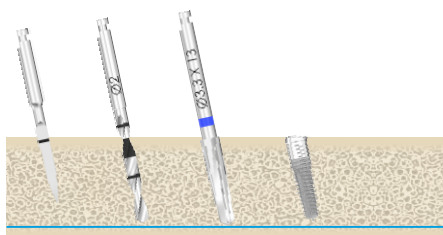

Dense Bone

D-3Spode-1.8M
Ø2.0 mm
Ø3.3 mm
D-TAP-IBNT

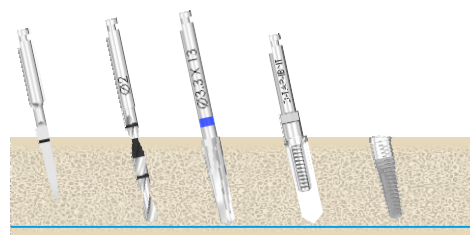

NOTE: site preparation sequence recommended by Southern Implants® does not replace the judgement and experience of the surgeon.

PROVATA®

Ø4.0 mm

Ø4.0 mm Implants

 Restore with standard interface components



PRO4xx

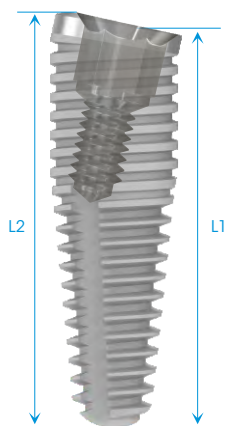

PRO12D4xx

(where xx is implant length)

Implants are available in lengths of:

NOTE: implant dimensions and information - page 34.

ITEM CODE TAPERED	MSC-TAPERED	IMPLANT LENGTHS (in mm)
PRO406	MSC-PRO406	6.4
PRO408	MSC-PRO408	8.5
PRO410	MSC-PRO410	10
PRO411	MSC-PRO411	11.5
PRO413	MSC-PRO413	13
PRO415	MSC-PRO415	15
PRO418	MSC-PRO418	18



ITEM CODE TAPERED	MSC-TAPERED	IMPLANT LENGTHS (in mm)	
		L1	L2
PRO12D408	MSC-PRO12D408	8.5	8.8
PRO12D410	MSC-PRO12D410	10	10.3
PRO12D411	MSC-PRO12D411	11.5	11.8
PRO12D413	MSC-PRO12D413	13	13.3
PRO12D415	MSC-PRO12D415	15	15.3
PRO12D418	MSC-PRO12D418	18	18.3

NOTE: all Co-Axis® implants are packaged with a fixture mount

NOTE:

- the regular PROVATA® implants are supplied without a fixture mount.
- the standard insertion tools (I-HM-GS, I-HM-M/L or I-WH-M-S/M/L) are to be used at regular implant level or at fixture mount level for Co-Axis® implants.

Surgical Components

Cover Screw

Healing Abutments

CS-M



HA-M-37

Ø3.7



3/4/6 lengths

HA-M-45

Ø4.5



3/4/6 lengths

HA-M-55

Ø5.5



3/4/6 lengths

Prosthetic Flowchart

DIRECT

Healing Abutments

- HA-M-37**
3/4/6
- HA-M-45**
4/6
- HA-M-45**
3
- HA-M-55**
3/4/6

Impression Copings

- ICT-M** (pick-up)
- ICT-MW** (pick-up)
- SFT-M** (scanning flag)
Titanium

Laboratory Analogues

- LA-M**
- LAD-M** (digital analogue)

Prosthetic Components

- DIRECT Abutments**
 - TC-M** (engaging)
TC-NM (non-engaging)
Titanium
 - GC-EM** (engaging)
GC-NM (non-engaging)
Gold
 - PKR-M-2** (engaging)
PKR-NM-2 (non-engaging)
PEEK*
*Screw torque: 15 Ncm
- TITANIUM Abutments**
 - TCA-M** (engaging)
 - TCA12-M** (engaging)
 - TCA24-M** (engaging)
- SCANNABLE Abutments**
 - TIB-M**
TIB-M-C1.5
TIB-M-C3 (engaging)
 - TIB-NM**
TIB-NM-C1.5
TIB-NM-C3 (non-engaging)
 - CAB-M** (engaging)
CAB-NM (non-engaging)
 - CIA-EM** (engaging)
CIA-NM (non-engaging)

TIB abutments available in 3 cuff height variants: 0.6 mm, 1.5 mm and 3 mm
- PASSIVE Abutments**
 - PA-EM-S** (engaging)
PA-NM-S (non-engaging)

Retaining Screws

- TS-Z-18**
Titanium (1.27 Hex)
TORQUE: 32 Ncm
- GS-Q-18**
Gold (Quad)
TORQUE: 32 Ncm
- BS-Z-18***
Brass (1.27 Hex)
*(Blackened and for laboratory use only)

Passive Abutment Screws

- PA-M-18T**
Titanium (1.27 Hex)
 - PA-Q-18G**
Gold (Quad)
 - PA-M-18B***
Brass (1.27 Hex)
*(Blackened and for laboratory use only)
- TORQUE: 32 Ncm

INDIRECT

Compact Conical Abutments

- MC-M**
1/2/3/4/5
- MC-M-20d***
- MC-M-30d***
*Packed with TS-Z-MC-18

- HMC**
4/6
- OR**
- HMCT7**
4/6

- CMC1** (pick-up)

- SFT-MC-48** (scanning flag)
Titanium

- CMC2** (transfer)
- CMC-ZG-2** (transfer)

- LSMC1**

- LAD-MC** (digital analogue)

- GMC1**
Gold

- TMC1 / 5**
Titanium
TMCSL (long version)

- PA-MC-48** (passive abutment)

- PKC-MC**
PEEK*
*Screw torque: 10 - 15 Ncm

- 1 Series Screws**
TORQUE: 10 - 15 Ncm

NOTE: for Equator overdenture abutments refer to CAT-1189.

Site Preparation Sequence

Ø4.0 mm (PRO4xx / MSC-PRO4xx)

(illustrations are for 13 mm implants)

Soft Bone

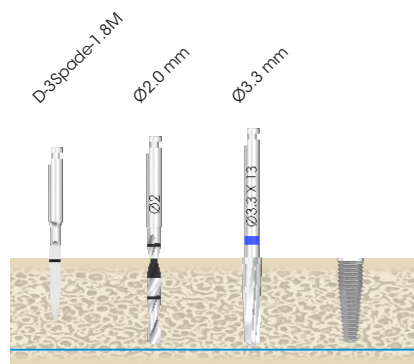

Medium Bone

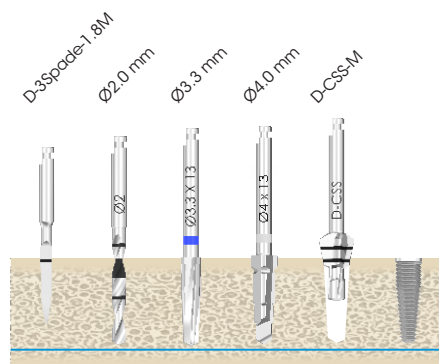

Dense Bone

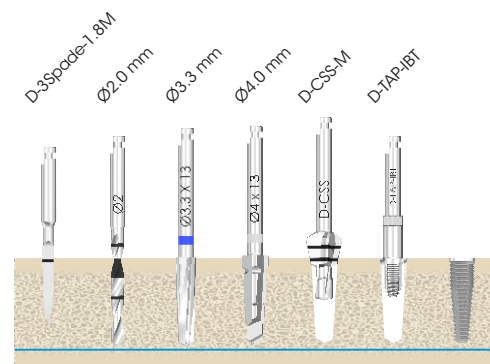

Ø4.0 mm Co-Axis® (PRO12D4xx / MSC-PRO12D4xx)

(illustrations are for 13 mm implants)

Soft Bone

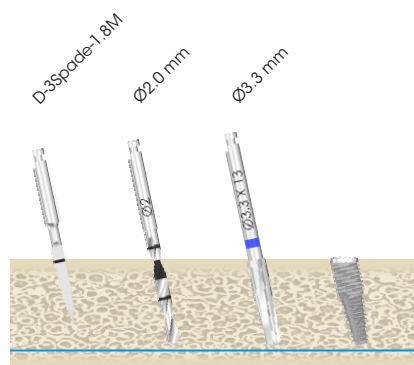

Medium Bone

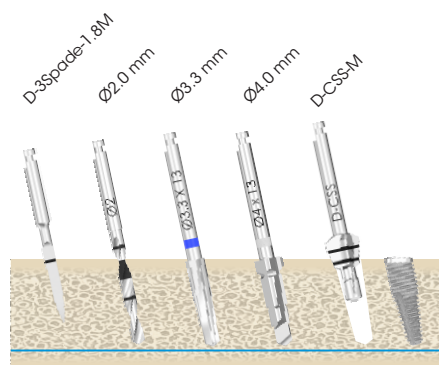

Dense Bone

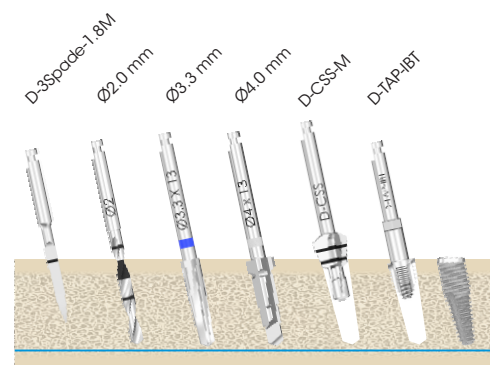

NOTE: site preparation sequence recommended by Southern Implants® does not replace the judgement and experience of the surgeon.

PROVATA®
Ø5.0 mm

PROMAX®
Ø6.0 mm

(Standard Interface)

 Restore with standard or platform matched interface components

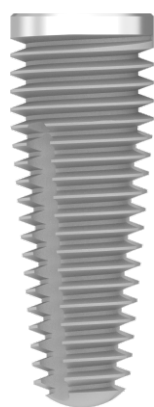

PRO5xx

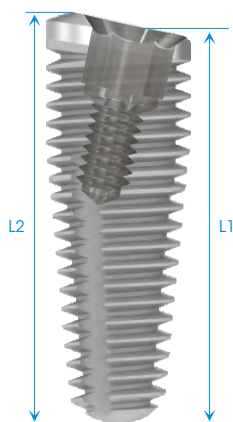

PRO12D5xx

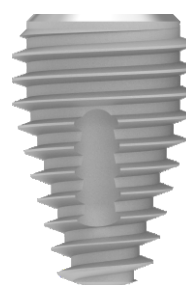

PROMAX6xx

(where xx is implant length)

NOTE: implant dimensions and information - page 34.

ITEM CODE TAPERED	MSC-TAPERED	IMPLANT LENGTHS (in mm)
PRO508	MSC-PRO508	8.5
PRO510	MSC-PRO510	10
PRO511	MSC-PRO511	11.5
PRO513	MSC-PRO513	13
PRO515	MSC-PRO515	15
PRO518	MSC-PRO518	18



ITEM CODE TAPERED	MSC-TAPERED	IMPLANT LENGTHS (in mm)	
		L1	L2
PRO12D508	MSC-PRO12D508	8.5	8.8
PRO12D510	MSC-PRO12D510	10	10.3
PRO12D511	MSC-PRO12D511	11.5	11.8
PRO12D513	MSC-PRO12D513	13	13.3
PRO12D515	MSC-PRO12D515	15	15.3
PRO12D518	MSC-PRO12D518	18	18.3

NOTE: all Co-Axis® implants are packaged with a fixture mount.

ITEM CODE TAPERED	MSC-TAPERED	IMPLANT LENGTHS (in mm)
PROMAX607	MSC-PROMAX607	7
PROMAX609	MSC-PROMAX609	9
PROMAX611	MSC-PROMAX611	11

- NOTE:**
- the regular PROVATA® implants are supplied without a fixture mount.
 - the standard insertion tools (I-HM-GS, I-HM-M/L or I-WI-M-S/M/L) are to be used at regular implant level or at fixture mount level for Co-Axis® implants.

Surgical Components

Cover Screw

CS-M



Healing Abutments

Standard Interface

HA-M-37

Ø3.7



3/4/6 lengths

HA-M-45

Ø4.5



3/4/6 lengths

HA-M-55

Ø5.5



3/4/6 lengths

Platform Matched Interface

HA-M-P45

Ø5.5



3 / 4 / 6 lengths

Prosthetic Flowchart

DIRECT

Healing Abutments

HA-M-37



3/4/6

HA-M-45



4/6

HA-M-45



3

HA-M-55



3/4/6

Impression Copings

ICT-M
(pick-up)



ICT-MW
(pick-up)



SFT-M
(scanning flag)



Titanium

Laboratory Analogues

LA-M



LAD-M

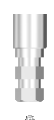

(digital analogue)

Prosthetic Components

TC-M
(engaging)
TC-NM
(non-engaging)



Titanium

GC-EM
(engaging)
GC-NM
(non-engaging)



Gold

PKR-M-2
(engaging)
PKR-NM-2
(non-engaging)



PEEK*
*Screw torque:
15 Ncm

DIRECT Abutments

TITANIUM Abutments

SCANNABLE Abutments

PASSIVE Abutments

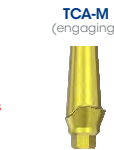

TCA-M
(engaging)



TCA12-M
(engaging)



TCA24-M
(engaging)

TIB-M
TIB-M-C1.5
TIB-M-C3
(engaging)



TIB-NM
TIB-NM-C1.5
TIB-NM-C3
(non-engaging)



CAB-M
(engaging)
CAB-NM
(non-engaging)



CIA-EM
(engaging)
CIA-NM
(non-engaging)



TIB abutments available in 3 cuff height variants:
0.6 mm, 1.5 mm and 3 mm

PA-EM-S
(engaging)
PA-NM-S
(non-engaging)



Passive Abutment Screws

PA-M-18T



Titanium
(1.27 Hex)

PA-Q-18G



Gold
(Quad)

PA-M-18B*



Brass
(1.27 Hex)

TORQUE:
32 Ncm

* (Blackened and
for laboratory
use only)

INDIRECT

Compact Conical Abutments

MC-M



1/2/3/4/5

MC-M-20d*



MC-M-30d*



* Packed with
TS-Z-MC-18

HMC



4/6

OR

HMCT7



4/6

CMC1
(pick-up)



CMC2
(transfer)



CMC-ZG-2
(transfer)



SFT-MC-48
(scanning flag)



Titanium

LSMC1



LAD-MC



(digital analogue)

GMC1



Gold

TMC1 / 5

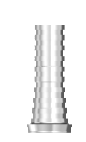

Titanium
TMCSL
(long version)

PKC-MC



PEEK*
*Screw torque:
10 - 15 Ncm

PA-MC-48
(passive abutment)



1 Series
Screws

TORQUE:
10 - 15 Ncm

NOTE: for Equator overdenture abutments refer to CAT-1189.

DIRECT

Healing Abutments

HA-M-P45



3/4/6 lengths

Impression Copings

ICT-MW-P45
(pick-up)



IC-MW-P45
(transfer)



SFT-M
(scanning flag)

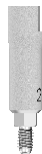

Titanium

Laboratory Analogues

LA-M-P45



LAD-M-P45



Digital Analogue

SCANNABLE Abutments

PASSIVE Abutments

Prosthetic Components

TIB-M-P45
(engaging)



CAB-M-P45
(engaging)



PA-EM-SP45
(engaging)



Passive Abutment Screws

PA-M-18T



Titanium
(1.27 Hex)

PA-Q-18G



Gold
(Quad)

PA-M-18B*



Brass
(1.27 Hex)

TORQUE:
32 Ncm

* (Blackened and for laboratory use only)

Retaining Screws

TS-Z-18



Titanium
(1.27 Hex)

TORQUE:
32 Ncm

GS-Q-18



Gold
(Quad)

TORQUE:
32 Ncm

BS-Z-18*



Brass
(1.27 Hex)

* (Blackened and for laboratory use only)

The Platform Matched Prosthetic Approach

In applications of the PROVATA® Ø5 mm and PROMAX® Ø6 mm implants, the platform matched approach is suggested. This approach uses the maximum implant platform dimension, in order to give the single tooth prosthetics greater stability.

The platform matched approach is indicated when:

- restoring a single posterior tooth.
- the patient is known to have a very strong bite and bruxism is present.
- the occlusal table of the crown will be significantly larger than that of the implant and abutment (Fig. 1).
- excessive cantilevers can't be avoided (Fig. 2).

Warning: these platform matched prosthetics are not compatible with PROVATA® Ø4 mm implants or PROVATA® Co-Axis® implants.

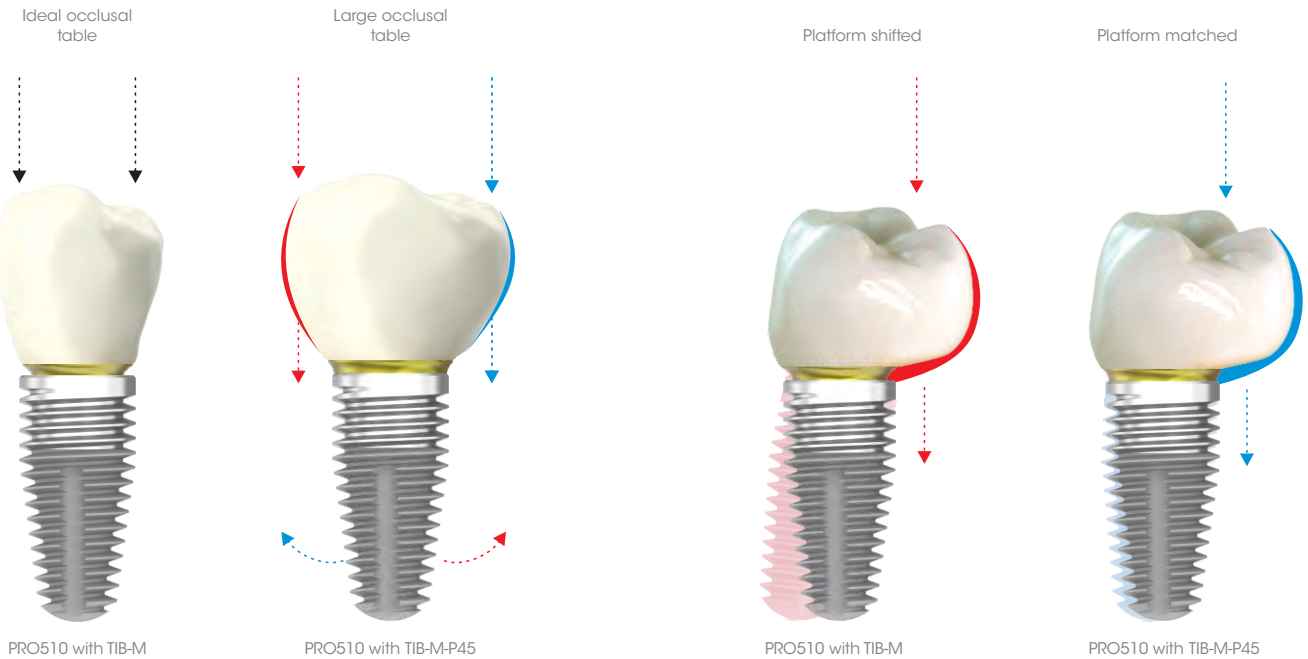
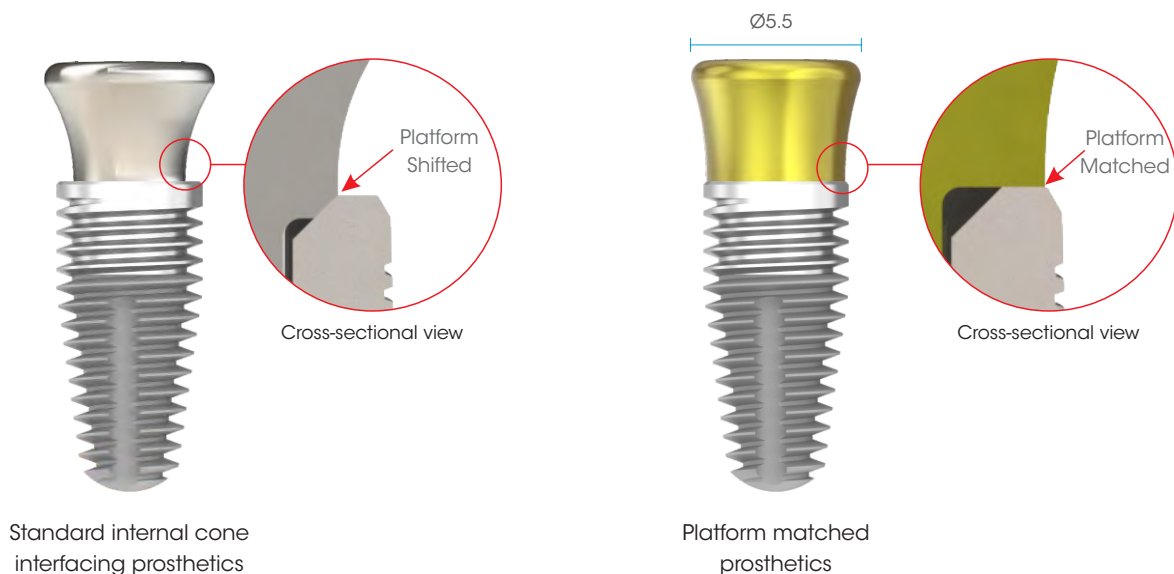

Fig 1: with large occlusal tables, maximise the platform dimension with platform matched components.

Fig 2: excessive cantilevers - use platform matched components to compensate for non-ideal crown-implant ratios.



After case planning either the standard platform or platform matched workflow can be followed.

Site Preparation Sequence

Ø5.0 mm (PRO5xx / MSC-PRO5xx)

(illustration is for 13 mm implants)

Soft Bone

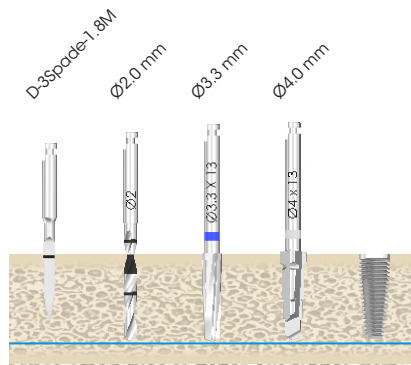

Medium Bone

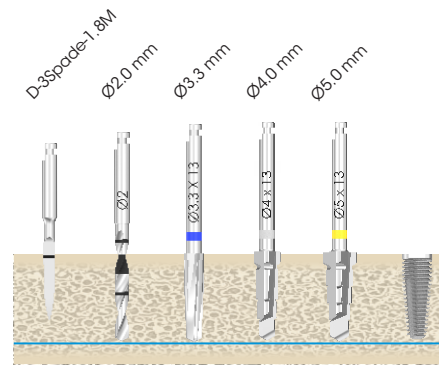

Dense Bone

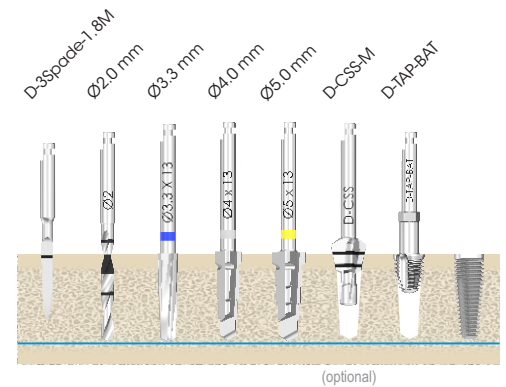

Ø5.0 mm Co-Axis® (PRO12D5xx / MSC-PRO12D5xx)

Soft Bone

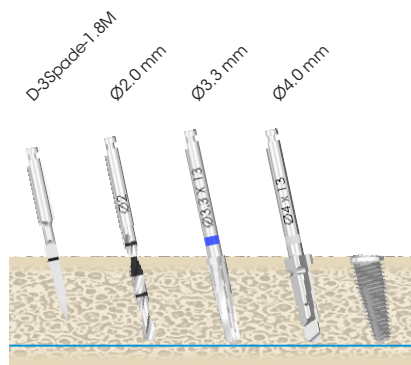

Medium Bone

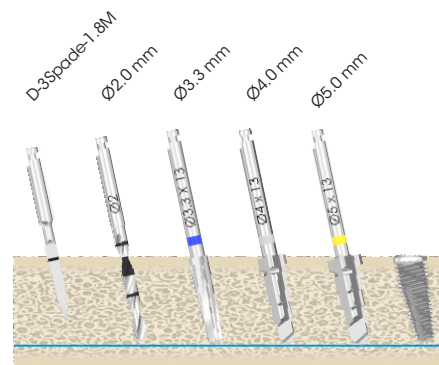

Dense Bone

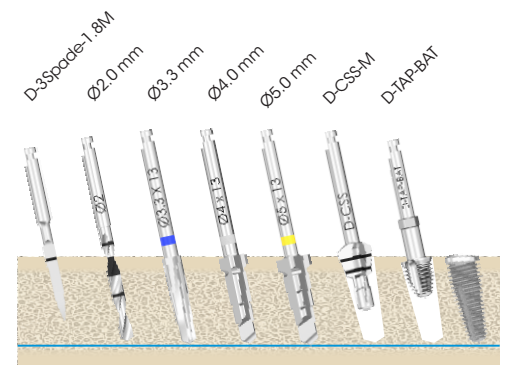

Ø6.0 mm Tapered (PROMAX6xx / MSC-PROMAX6xx)

(illustration is for 9 mm implants)

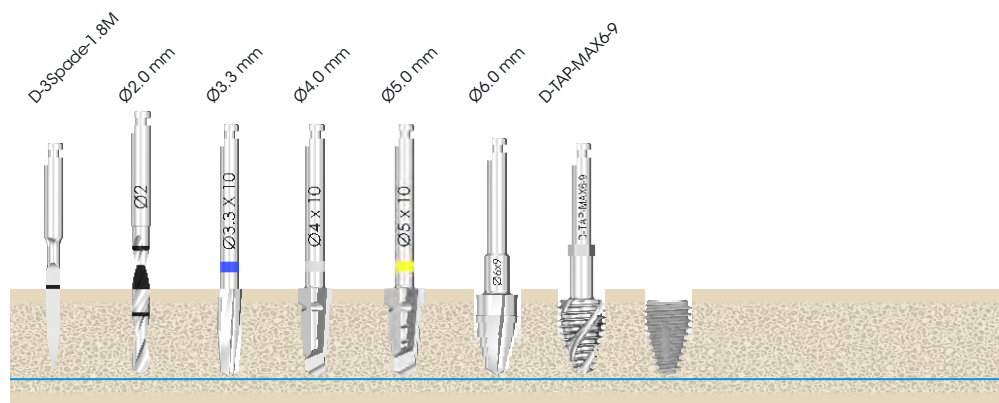

NOTE:

- site preparation sequence recommended by Southern Implants® does not replace the judgement and experience of the surgeon.
- drill length of intermediate drills may differ from the length of definitive drills.

PROVATA®
Ø6.0 mm

PROMAX®
Ø7.0 mm
Ø8.0 mm
Ø9.0 mm

(Wide Interface)

 Restore with wide interface components

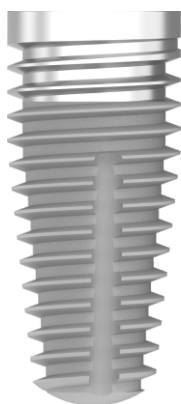

MSC-PRO6xx

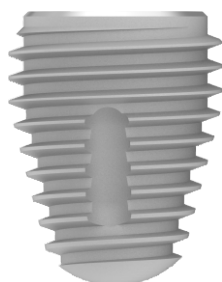

PROMAX7xx



PROMAX8xx



PROMAX9xx

(where **xx** is implant length)

Implants are available in lengths of:

NOTE: implant dimensions and information - page 34.

ITEM CODE TAPERED	IMPLANT LENGTHS (in mm)
MSC-PRO608	8.5
MSC-PRO610	10
MSC-PRO611	11.5
MSC-PRO613	13
MSC-PRO615	15

ITEM CODE TAPERED	IMPLANT LENGTHS (in mm)
PROMAX707	7
PROMAX709	9
PROMAX711	11

ITEM CODE TAPERED	IMPLANT LENGTHS (in mm)
PROMAX807	7
PROMAX809	9
PROMAX811	11

ITEM CODE TAPERED	IMPLANT LENGTHS (in mm)
PROMAX907	7
PROMAX909	9
PROMAX911	11

MSC-TAPERED	IMPLANT LENGTHS (in mm)
MSC-PROMAX707	7
MSC-PROMAX709	9
MSC-PROMAX711	11

MSC-TAPERED	IMPLANT LENGTHS (in mm)
MSC-PROMAX807	7
MSC-PROMAX809	9
MSC-PROMAX811	11

MSC-TAPERED	IMPLANT LENGTHS (in mm)
MSC-PROMAX907	7
MSC-PROMAX909	9
MSC-PROMAX911	11

Surgical Components

Cover Screw

Healing Abutments

Anatomically shaped abutments

CS-Z



HA-Z6



3/6 lengths

HA-Z8



3/6 lengths

PKA-Z6-9



PEEK

PKA-Z8-11

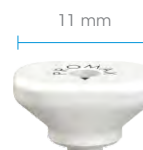

PEEK

Retaining screw sold separately (TS-Z-18)

Prosthetic Flowchart

DIRECT

Healing Abutments



Impression Copings

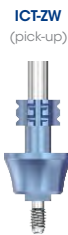

Laboratory Analogues



Prosthetic Components

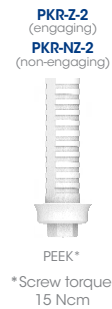
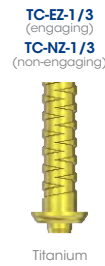

DIRECT Abutments

TITANIUM Abutments

SCANNABLE Abutments

PASSIVE Abutments

Retaining Screws



Passive Abutment Screws



TORQUE: 32 Ncm

INDIRECT

Compact Conical Abutments



1 Series Screws
TORQUE: 10 - 15 Ncm

NOTE: for Equator overdenture abutments refer to CAT-1189.

Site Preparation Sequence

Ø6.0 mm (MSC-PRO6)

(illustration is for 13 mm implants)

Soft Bone

D-3Spode-1.8M
Ø2.0 mm
Ø3.3 mm
Ø4.0 mm
Ø5.0 mm

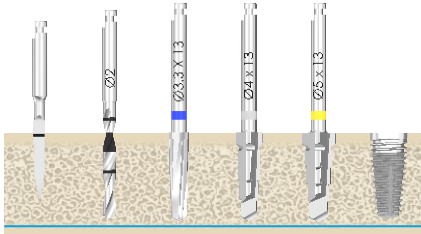

Medium Bone

D-3Spode-1.8M
Ø2.0 mm
Ø3.3 mm
Ø4.0 mm
Ø5.0 mm
Ø6.0 mm

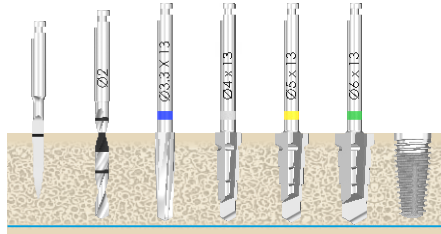

Dense Bone

D-3Spode-1.8M
Ø2.0 mm
Ø3.3 mm
Ø4.0 mm
Ø5.0 mm
Ø6.0 mm
D-1AP-B98T

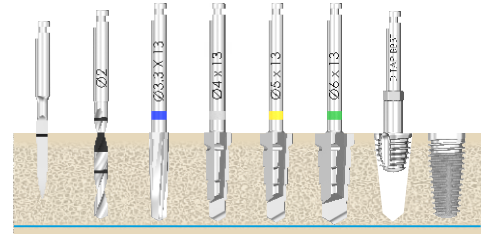

NOTE: site preparation sequence recommended by Southern Implants® does not replace the judgement and experience of the surgeon.

Site Preparation Sequence

Ø7.0 mm (PROMAX7 / MSC-PROMAX7)

(illustrations are for 9 mm implants)

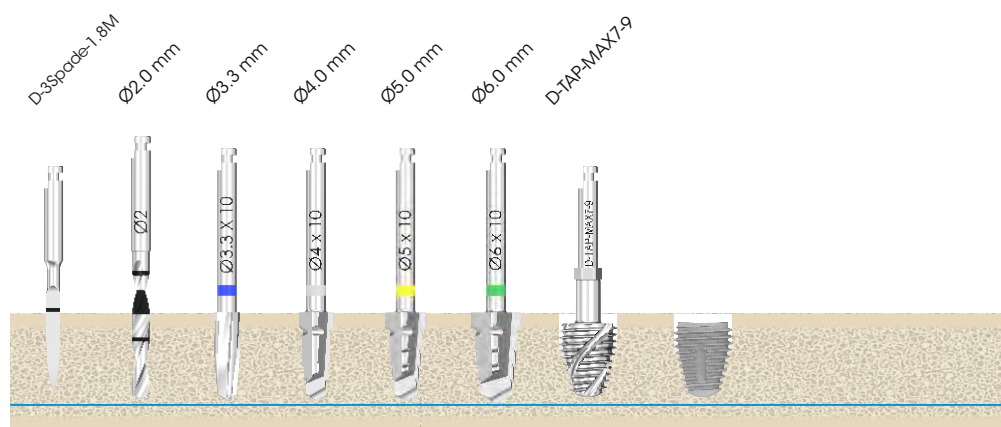

Ø8.0 mm (PROMAX8 / MSC-PROMAX8)

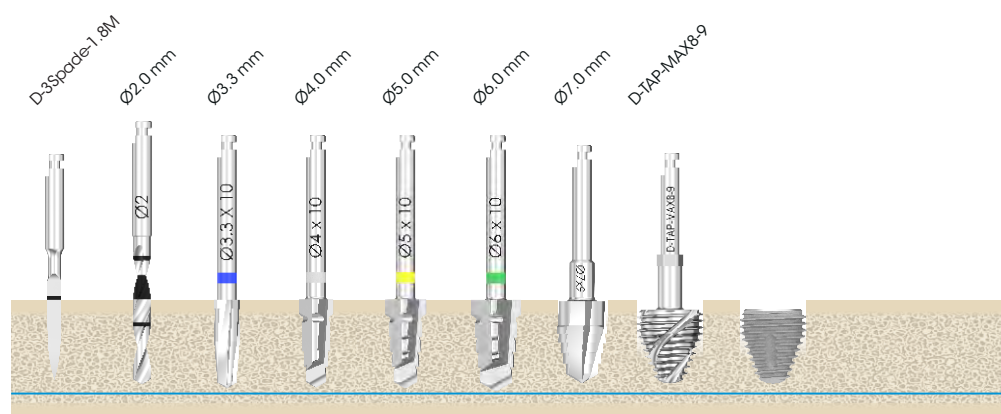

Ø9.0 mm Tapered (PROMAX9 / MSC-PROMAX9)

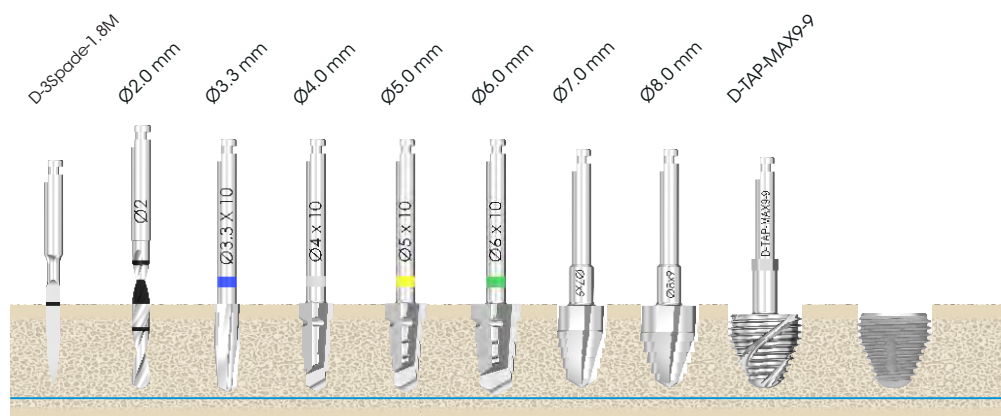

NOTE:

- site preparation sequences recommended by Southern Implants® do not replace the judgement and experience of the surgeon.
- drill length of intermediate drills may differ from the length of definitive drills.

SFT-PRO3 Multipurpose Fixture Mount/Scan Flag/Impression Coping

SFT-PRO3 is a Multiple Purpose Fixture Mount which can be used as a fixture mount to transmit torque to the implant during placement as well as be used during manual and digital impression procedures to replicate the exact position and orientation of the respective dental implant or laboratory analogue. The multipurpose fixture mount is premounted on Ø3.3 mm PROVATA® (MSC-PRO3) implants. Should a clinician wish to order a Ø3.3 mm PROVATA® without the fixture mount, they are able to order the 'NF' (No Fixture Mount) version as indicated in the item code. The SFT-PRO3 can then be ordered separately.

NOTE:

- Co-Axis® PRO3 implants use standard fixture mounts (NOT the multipurpose fixture mount).
- SFT-PRO3 packaged with both a retaining screw (TS-Z-16) and an impression coping pin (ICT-3M-S), depending on the clinicians' preference for impression taking (pick-up, transfer or via scanning).

Compatible Drivers

1.22 mm / 1.27 mm universal drivers



Use as a Fixture Mount (for regular implants only)

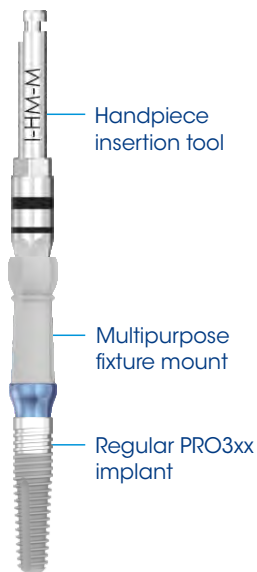

1. Connect the standard handpiece insertion tool (IHM-M/L) to the handpiece (see CAT-8056).
2. Engage the internal hex of the multiple purpose fixture mount with the insertion tool and carefully remove the implant-fixture mount assembly from the sterile vial. The hexagon of the insertion tool in the multiple purpose fixture mount must be fully engaged before torque is applied, to prevent any damage. The hexagon is fully engaged when the hexagon of the insertion tool is almost completely sunken in the multiple purpose fixture mount.
3. Insert the implant at 15 - 20 rpm while applying downward pressure.
4. Once the implant is placed to the desired depth, remove the multipurpose fixture mount by loosening the screw using the applicable driver.

NOTE:

- there are dedicated insertion tools (i.e IH3M-M/L or IWI-3M-S/M/L) should the user wish to place a regular PRO3 implant without a fixture mount.
- the standard insertion tools (IHM-S/M/L or IWI-M-S/M/L) are to be used at fixture mount-level for both the regular and Co-Axis PRO3 implants.

SFT-PRO3 Multipurpose Fixture Mount/Scan Flag/Impression Coping

Use as a Scan Flag

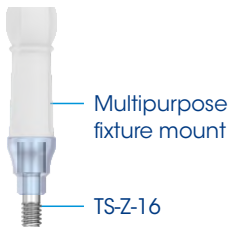

1. Attach the matching multipurpose fixture mount to the dental implant or lab analogue using the retaining screw (TS-Z-16). Should the implant in use already have a multipurpose fixture mount, ensure that the retaining screw is tightened before proceeding to the next step. Check proper fit and hand tighten the screw with the appropriate driver. The seating of the multipurpose fixture mount must be verified before intraoral scanning procedures by an X-ray.
2. The patient is scanned using an intraoral scanner or digitalisation at the model phase can occur if the laboratory model is scanned using a desktop scanner.
NOTE: follow the instructions for use which are supplied by the scanner manufacturer for both handling of the scanning device as well as scanning procedures.
3. Follow the recommended scanning protocol as set out by the scanning device operating manual. Take special care to capture the top third of the scan flag fully. This area is the "alignment zone" needed to match the scan flag to its digital counterpart within the SIDIGITAL libraries for 3Shape, Exocad and Dental Wings. (SIDIGITAL libraries are available for download at southernimplants.com).

Use as an Impression Coping - Transfer Impression (closed tray technique)

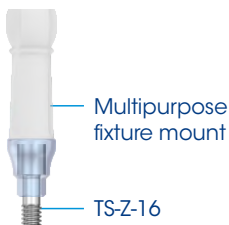

1. Screw the multipurpose fixture mount into the implant using the retaining screw (TS-Z-16). Should the implant in use already have a multipurpose fixture mount, ensure that the retaining screw is tightened before proceeding to the next step. Check proper fit and hand tighten the screw with the appropriate driver. The seating of the multipurpose fixture mount must be verified before intraoral scanning procedures by an X-ray.
2. Ensure that the impression material surrounds the multipurpose fixture mount to verify an accurate representation of the tissue profile. Use either a custom or stock tray (there is no need to cut an opening into the tray as this is a closed tray technique).
3. Fill the impression tray with impression material and take the impression.
4. Once the impression material has set, remove the impression from the patient's mouth. If multiple implants are being restored, remove one multipurpose fixture mount at a time from the patient and insert it into the correlating position in the impression tray. Proceed with restoration procedure as deemed necessary.

NOTE: it is important to place the multipurpose fixture mount into the same opening in the material and in the same orientation as it was orientated in the mouth.

Use as an Impression Coping - Pick-up impression (open tray technique)

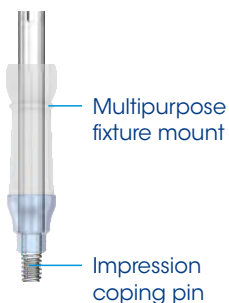

1. Screw the multipurpose fixture mount into the implant using the impression pin packaged with the SFT-PRO3. Check proper fit and hand tighten the screw with the appropriate driver.
2. Ensure that the impression material surrounds the multipurpose fixture mount to verify an accurate representation of the tissue profile.
3. Use either a custom or stock tray (cut an opening into the tray as this is an open tray technique). Fill the impression tray with impression material and take the impression.
4. Once the impression material has set, remove the impression pin from the patient's mouth by unscrewing the impression pin and removing it.
5. Remove the impression tray (containing the multipurpose fixture mount). Proceed with restoration procedure as deemed necessary.

TOP TRAY

Counter Sink

D-CSS



Counter Bore

D-CB-F
D-CB-40M
D-CB-50M



Pilot Drills

D-3Spade-1.8M
D-RB-MS
D-12T-M15
D-16-T



Ø2.0 mm Twist Drills

D-20T-M10
D-20T-M15



External Hex Dedicated Tapered Drills

Ø3.0
D-30TP-8.5
D-30TP-10
D-30TP-11.5
D-30TP-13
D-30TP-15



Ø3.3
D-33TP-8.5
D-33TP-10
D-33TP-11.5
D-33TP-13
D-33TP-15
D-33TP-18



Ø4.0
D-40TP-6
D-40TP-8.5
D-40TP-10
D-40TP-11.5
D-40TP-13
D-40TP-15
D-40TP-18



Ø5.0
D-50TP-6
D-50TP-8.5
D-50TP-10
D-50TP-11.5
D-50TP-13
D-50TP-15
D-50TP-18



Ø6.0
D-60TP-6
D-60TP-8.5
D-60TP-10
D-60TP-11.5
D-60TP-13
D-60TP-15
D-60TP-18



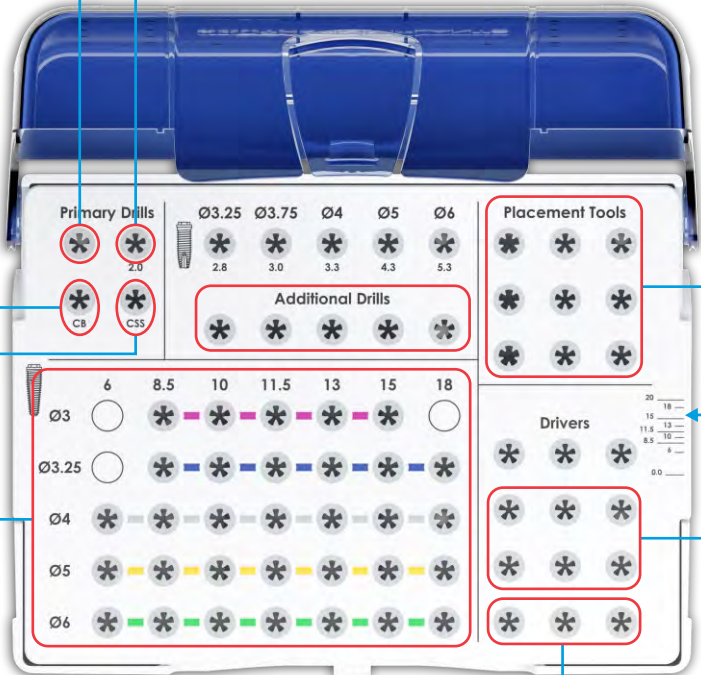

Primary Drills: Ø3.25, Ø3.75, Ø4, Ø5, Ø6
Additional Drills: 6, 8.5, 10, 11.5, 13, 15, 18
Placement Tools
Drivers
Drill / Implant length measure

Insertion Tools

I-H3M-M/L
I-WI-3M-S/M/L



I-HM-S/M/L
I-WI-S/M/L

I-HZ-S/M/L
I-WI-ZS/M/L







Abutment Drivers (Hex)

I-AD Handheld
I-HAD Handpiece Insert
I-WI-A Wrench Insert





Hex Drivers
Universal 1.22/1.27

HEX22U-M
I-HD-22U-S/M/L Handheld
I-HHD-22U-S/M/L Handpiece Insert
I-WI-22U-S/M/L Wrench Insert







Quad Drivers

QJAD-M
I-QDI-S/M/L Handheld
I-HQD-S/M/L Handpiece Insert
I-WI-QS/M/L Wrench Insert

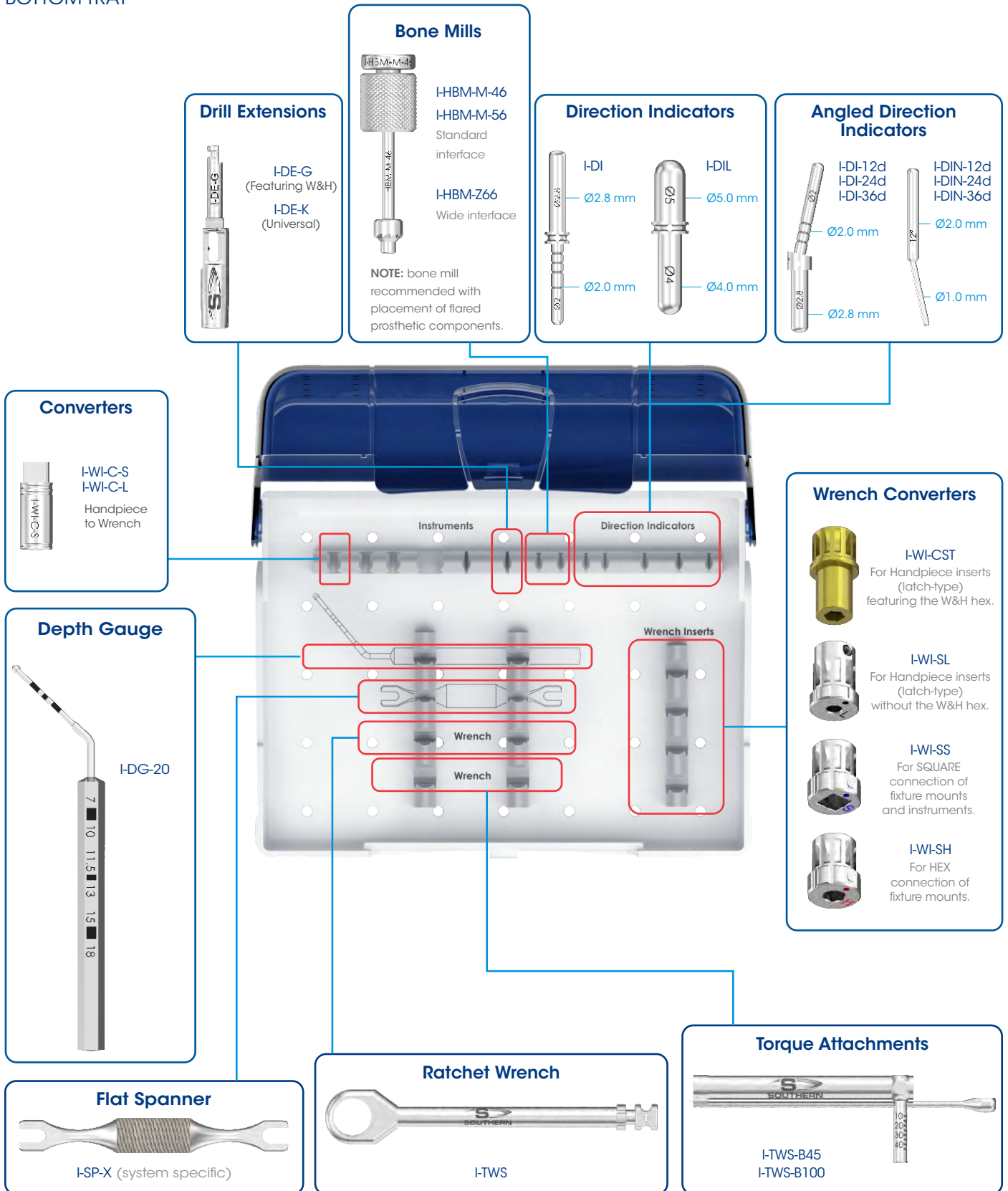





BOTTOM TRAY

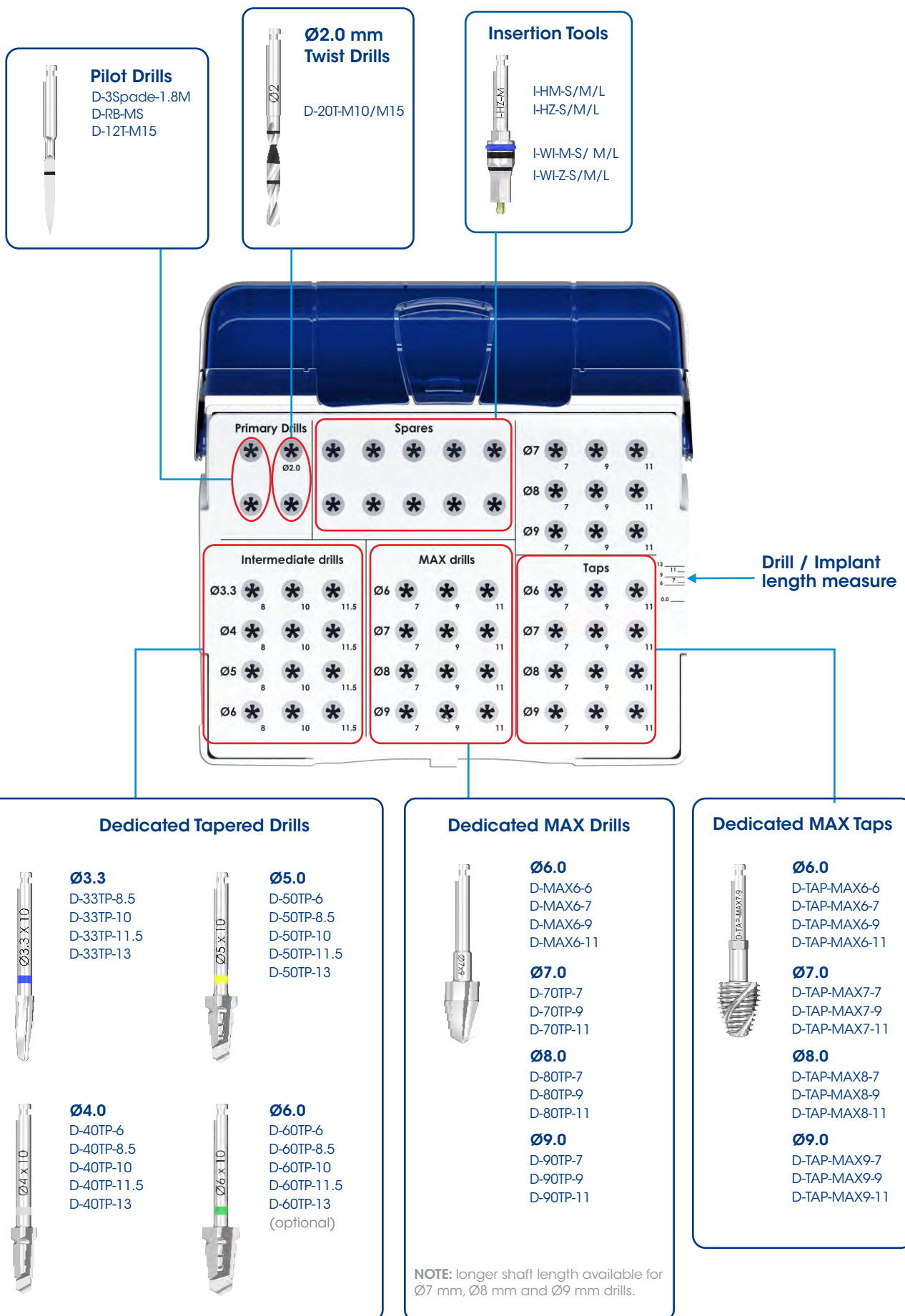

- NOTE:**
- the instrument tray has an intuitive layout to guide the surgeon through the drill sequence.
 - most instruments are available in various lengths.
 - all instruments and tooling used during the procedure must be maintained in good condition, cleaned and sterilized prior to use. Please consult the Instructions for Use: Southern Implants® instrument tray and reusable instruments (CAT-8003 and CAT-8070) for guidance concerning the maintenance of instruments and surgical trays. Please consult the corresponding drill Instructions for Use regarding care and maintenance of drills.
 - refer to CAT-8035 for more information on bone mills.

TOP TRAY



BOTTOM TRAY

Converter

I-WI-C-S
I-WI-C-L

Bone Mills

I-HBM-M-46
I-HBM-M-56
Standard interface

I-HBM-Z66
Wide interface

NOTE: Bone mill recommended with placement of flared prosthetic components.

Drivers

ABUTMENT Drivers
I-AD
I-HAD
I-WI-S

Cover Screw Drivers
I-CS-HD/L
I-HHD-09
I-WI-09

1.22 mm HEX
I-HD-S/M/L
I-HHD-22-S/M/L
I-WI-22-S/M/L

1.22/1.27 mm Universal HEX
I-HD22U-S/M/L
I-HHD-22U-S/M/L
I-WI-22U-S/M/L

Quad
I-QDI-S/M/L
I-HQD-S/M/L
I-WI-QS/M/L

Direction Indicators

I-DI
I-DIL

Ø2.8 mm
Ø2.0 mm

Depth Gauge

I-DG-20

Wrench Converters

I-WI-CST
For Handpiece inserts (latch-type) featuring the W&H hex.

I-WI-SL
For Handpiece inserts (latch-type) without the W&H hex.

I-WI-SS
For SQUARE connection of fixture mounts and instruments.

I-WI-SH
For HEX connection of fixture mounts.

Flat Spanner

I-SP-X (system specific)

Ratchet Wrench

I-TWS

Torque Attachments

I-TWS-B45
I-TWS-B100

NOTE:

- the instrument tray has an intuitive layout to guide the surgeon through the drill sequence.
- most instruments are available in various lengths.
- all instruments and tooling used during the procedure must be maintained in good condition, cleaned and sterilized prior to use. Please consult the Instructions for Use: Southern Implants® instrument tray and reusable instruments (CAT-8003 and CAT-8070) for guidance concerning the maintenance of instruments and surgical trays. Please consult the corresponding drill Instructions for Use regarding care and maintenance of drills.
- refer to CAT-8035 for more information on bone mills.

TOP TRAY

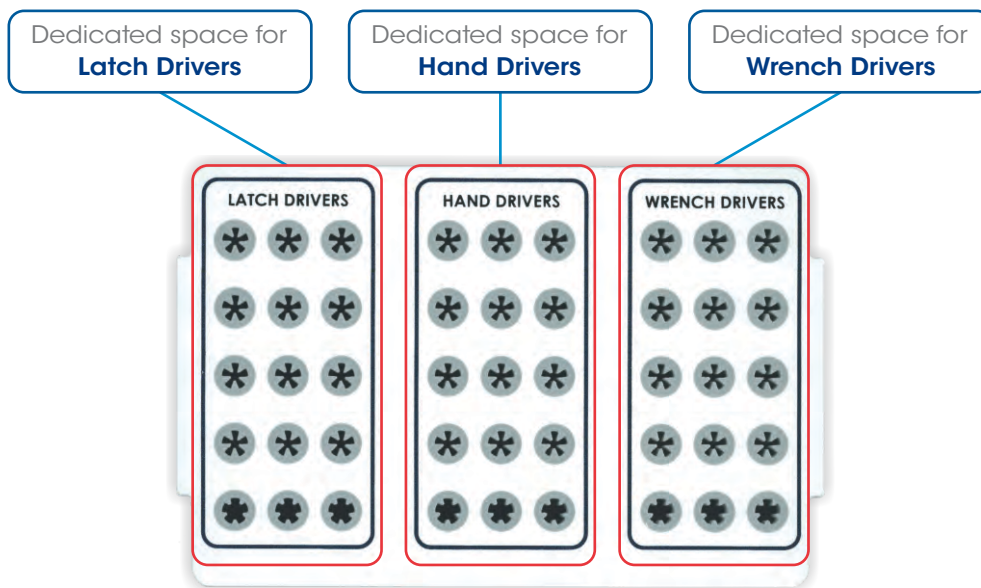

BOTTOM TRAY

Flat Spanner
I-SP-X (system specific)

Ratchet Wrench
I-TWS

Torque Attachments
I-TWS-B45
I-TWS-B100

Wrench Converters

- I-WI-CST**
For Handpiece inserts (latch-type) featuring the W&H hex.
- I-WI-SL**
For Handpiece inserts (latch-type) without the W&H hex.
- I-WI-SS**
For SQUARE connection of fixture mounts and instruments.
- I-WI-SH**
For HEX connection of fixture mounts.

NOTE:

- this instrument tray is to be customised by the user to be suitable for use with the preferred implant system and its surgical or prosthetic items.
- most instruments are available in various lengths.

TORQUE TABLE FOR SOUTHERN SCREWS

1.27 Hex Prosthetic screws

Quad Prosthetic screws

M1.6



TS-Z-16

BS-Z-16*

TORQUE:
25 - 32 Ncm
Head diameter:
2.30 mm
Screw TORQUE with
PEEK prosthetics:
15 Ncm

M1.8



TS-Z-18

BS-Z-18*

GS-Q-18

TORQUE:
32 Ncm
Head diameter:
2.25 mm
Screw TORQUE with
PEEK prosthetics:
15 Ncm

1.27 Hex Passive Abutment screws

Quad Passive Abutment screws

M1.6



PA-M-16T

PA-M-16B*

TORQUE:
25 - 32 Ncm
Head diameter:
2.20 mm

M1.8



PA-M-18T

PA-M-18B*

PA-Q-18G

TORQUE:
32 Ncm
Head diameter:
2.60 mm

Digital Laboratory Analogue screw

1.22 Hex



LAD-S

Screw supplied with all digital analogues.

TORQUE:
Finger tighten
Head diameter:
2.40 mm

1 Series screws (M1.4)

1.22 Hex



TSH1

GSH1

BSH1*

Slotted



TSS1

GSS1

BSS1*

Unigrip



TSU1

GSU1

TORQUE:
10 - 15 Ncm
Head diameter:
2.25 mm
Screw TORQUE with
PEEK prosthetics:
10 - 15 Ncm

NOTE:

- due to design revisions screw tips may be flat or rounded.
- always ensure that the correct screw is used for the relevant implant and component.
- refer to CAT-8068 for alternative slotted 1 series screws.

- * blackened and for laboratory use only.
- universal drivers are compatible with both 1.22 and 1.27 hex screws:
 - I-HD22U-S/M/L
 - I-HHD-22U-S/M/L
 - I-WI-22U-S-/M/L

Screw Head Connections

Hex



Slotted

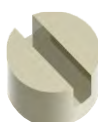

Unigrip



Quad



MSC IMPLANTS EXPLAINED

MSC stands for **Machined Surface Coronally**.

Capturing the advantage of Southern's proven rough surface where it is needed most. The "smoother" coronal machined surface is engineered to reduce bacterial adhesion and thus, decrease the risk of infection which could lead to marginal bone loss.¹

Indicated for patients with higher risk of coronal bone loss (smokers, history of periodontitis and cardio-vascular disease).

The coronal machined surface area covers the top crestal 3 mm of the implant (2 mm for the MSC-PRO406).

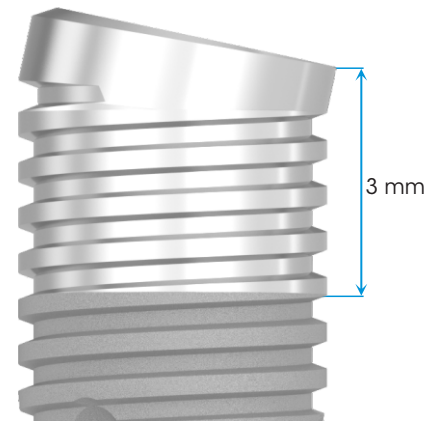

1. Vandeweghe S, Ferreira D, Vermeersch L, Mariën M, De Bruyn H. Long-term retrospective follow-up of turned and moderately rough implants in the edentulous jaw. Clin Oral Implants Res. 2016 Apr;27(4):421-6.

DRILL INFORMATION

Twist drill markings

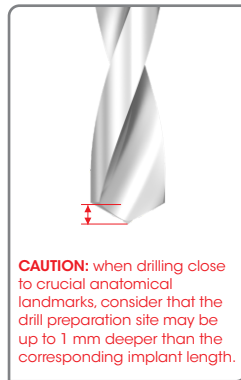
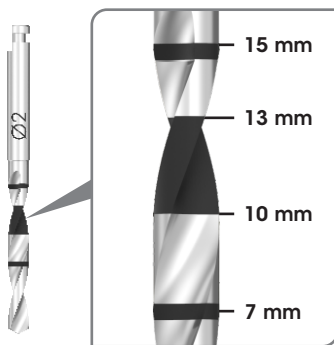

Final tapered drill position for Co-Axis® implants

PLEASE NOTE:

Point 1
This corner of the drill is to be at bone level.

Point 2
This corner of the drill will be subcrestal.

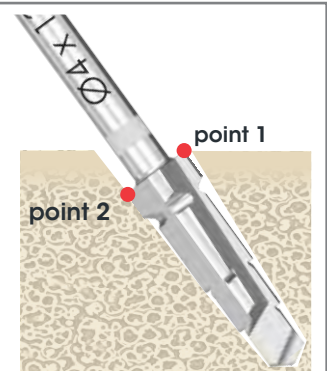

INSERTION TOOL PROTOCOL

Implant Placement Procedure for PROVATA® and PROMAX®

1. The tools I-H3M-M / L (narrow interface), I-HM-S / M / L (standard interface) and I-HZ-M / L (wide interface) are used to pick up the implant from the packaging.
2. The hexagon of the insertion tool in the implant must be fully engaged before torque is applied, to prevent any damage. The hexagon is fully engaged when the standard portion of the hexagon tool is almost completely sunken in the implant (Fig.3).
3. The implant is placed in the prepared site and inserted in with a motor unit at 15 rpm while applying downwards pressure.

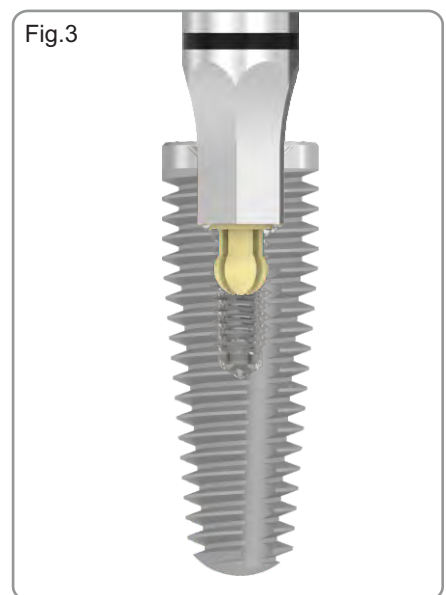

INSERTION TOOL DEPTH MARKINGS

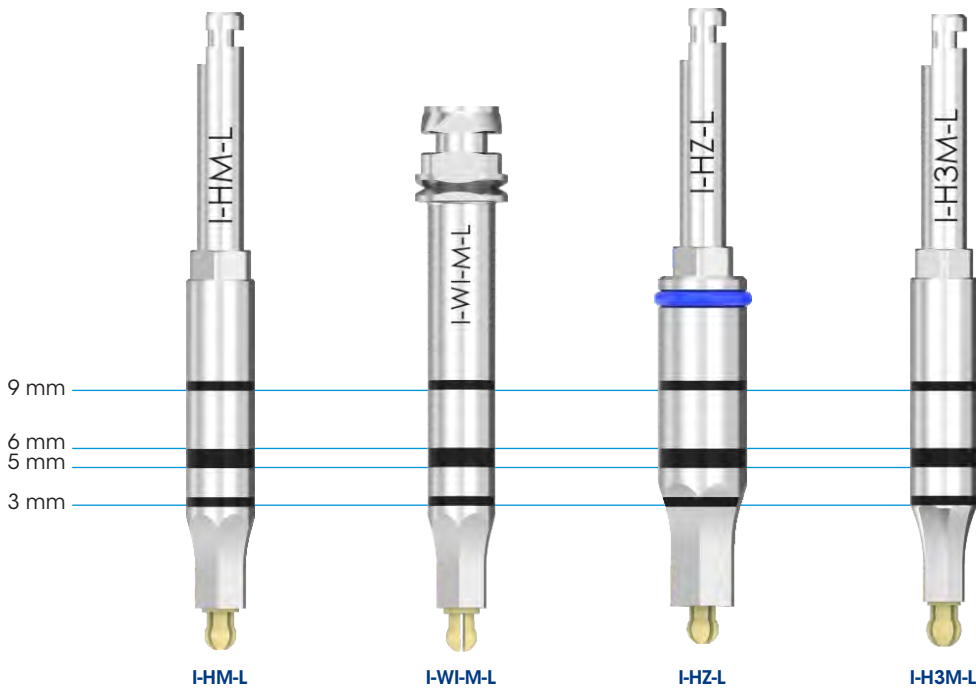

NOTE:

- Laser markings at 3 mm, 5 mm, 6 mm and 9 mm from implant platform.
- refer to CAT-8056 for insertion tool markings and depths.

Important: the PEEK bits (I-PBIT-L18 and I-PBIT-H16) should be replaced on a regular basis. Items sold separately. General wear and tear are to be expected with regular use.

CO-AXIS® FIXTURE MOUNT REMOVAL PROTOCOL

1. The tool I-HM-S / M / L is used to pick up the implant from the packaging (Fig.4) after attaching it to the fixture mount.
2. Once the implant is placed and the position verified, after final X-rays have been taken, remove the fixture mount by unscrewing the fixture mount screw using a I-HD-22U-S / M / L handheld driver (Fig.5).

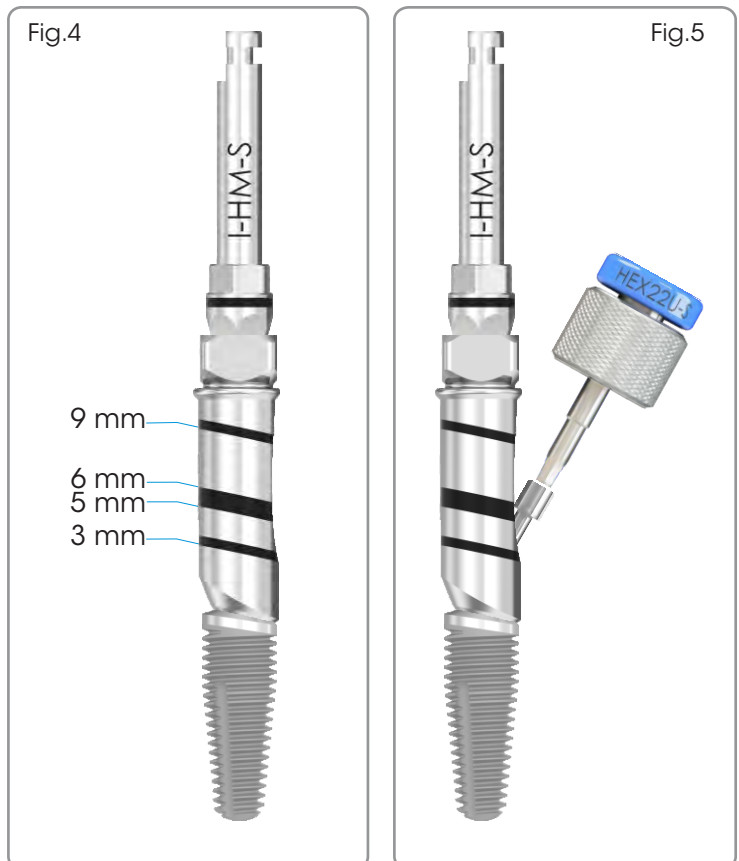

NOTE: Co-Axis® fixture mount laser markings at 3 mm, 5 mm, 6 mm and 9 mm from implant platform.

IMPLANT DIMENSIONS AND INFORMATION



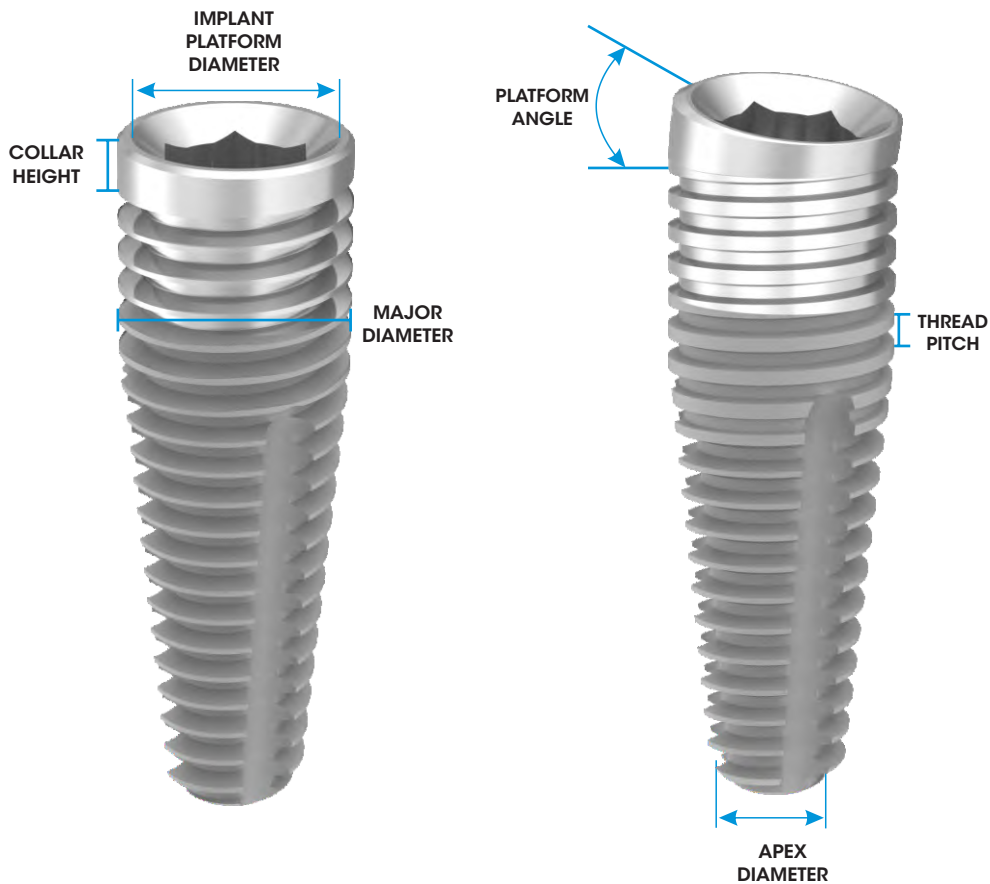



















RANGE	MAJOR DIAMETER	IMPLANT PLATFORM DIAMETER	PROSTHETIC DIAMETER	PROSTHETICS	HEX WIDTH (across flats)	COLLAR HEIGHT	THREAD PITCH	APEX DIAMETER	CYLINDRICAL OR TAPERED	PLATFORM ANGLE	IMPLANT LENGTH CODES							
											6	8	10	11	13	15	18	
● MSC-PRO3xx	Ø3.3 mm	3.30	3.10	2.9	●	2.10	0.6	0.6	2.6	T		✓	✓	✓	✓	✓	✓	
● MSC-PRO3xxNF	Ø3.3 mm	3.30	3.10	2.9	●	2.10	0.6	0.6	2.6	T		✓	✓	✓	✓	✓	✓	
● PRO4xx	Ø4.0 mm	4.07	3.87	3.6	●	2.44	0.6	0.6	2.6	T		✓	✓	✓	✓	✓	✓	
● MSC-PRO4xx	Ø4.0 mm	4.07	3.87	3.6	●	2.44	0.6	0.6	2.6	T		✓	✓	✓	✓	✓	✓	
● PRO5xx	Ø5.0 mm	4.70	4.5	3.6 / 4.5	● / ●	2.44	0.6	0.6	3.13	T		✓	✓	✓	✓	✓	✓	
● MSC-PRO5xx	Ø5.0 mm	4.70	4.5	3.6 / 4.5	● / ●	2.44	0.6	0.6	3.13	T		✓	✓	✓	✓	✓	✓	
● MSC-PRO6xx	Ø6.0 mm	5.70	5.6	5.6	●	3.06	0.6	0.8	4.0	T		✓	✓	✓	✓	✓	✓	
● MSC-PRO12D3xx	Ø3.3 mm	3.30	3.10	3.0	●	2.10	0.6	0.6	2.6	T	12°	✓	✓	✓	✓	✓	✓	
● PRO12D4xx	Ø4.0 mm	4.07	3.75	3.6	●	2.44	0.6	0.6	2.6	T	12°	✓	✓	✓	✓	✓	✓	
● MSC-PRO12D4xx	Ø4.0 mm	4.07	3.75	3.6	●	2.44	0.6	0.6	2.6	T	12°	✓	✓	✓	✓	✓	✓	
● PRO12Dxx5	Ø5.0 mm	4.70	3.75	3.6	●	2.44	0.6	0.6	3.13	T	12°	✓	✓	✓	✓	✓	✓	
● MSC-PRO12D5xx	Ø5.0 mm	4.70	3.75	3.6	●	2.44	0.6	0.6	3.13	T	12°	✓	✓	✓	✓	✓	✓	
												7	9	11				
● PROMAX6xx	Ø6.0 mm	6.0	4.5	3.6 / 4.5	● / ●	2.44	0.25	0.8	3.0	T		✓	✓	✓				
● MSC-PROMAX6xx	Ø6.0 mm	6.0	4.5	3.6 / 4.5	● / ●	2.44	0.25	0.8	3.0	T		✓	✓	✓				
● PROMAX7xx	Ø7.0 mm	7.0	5.7	5.6	●	3.06	0.15	0.8	4.44	T		✓	✓	✓				
● MSC-PROMAX7xx	Ø7.0 mm	7.0	5.7	5.6	●	3.06	0.15	0.8	4.44	T		✓	✓	✓				
● PROMAX8xx	Ø8.0 mm	8.0	6.5	5.6	●	3.06	0.25	0.8	3.94	T		✓	✓	✓				
● MSC-PROMAX8xx	Ø8.0 mm	8.0	6.5	5.6	●	3.06	0.25	0.8	3.94	T		✓	✓	✓				
● PROMAX9xx	Ø9.0 mm	9.0	7.5	5.6	●	3.06	0.25	0.8	4.94	T		✓	✓	✓				
● MSC-PROMAX9xx	Ø9.0 mm	9.0	7.5	5.6	●	3.06	0.25	0.8	4.94	T		✓	✓	✓				



- NOTE:**
- all dimensions in this catalogue are in mm, unless otherwise specified.
 - where 'xx' refers to implant length.
 - 'NF' in the item code denotes that the implant is packaged without a fixture mount.
 - not all products are cleared for sale in all countries.

EXPLANATION OF SYMBOLS

The following symbols are used on packaging labels and they indicate the following:

- 1  Manufacturer
- 2  Colour code indicating platform diameter
- 3  Implant image
- 4  Implant details and size
- 5  Sterilization using Irradiation
-  European Representative
-  Catalogue number
-  Batch Code
-  Do not Resterilise
-  Consult instruction for use
-  Do not reuse
-  CE mark and notified body number
-  Use by Date
-  Date of manufacture
-  Do not use if package is damaged
-  Identifies the product as a medical device
-  MR Conditional / Magnetic Resonance Conditional
-  Single sterile barrier system
-  Double sterile barrier
- 6  2D Bar coding
Contains the GTIN, Use by date and LOT number
- 7  Patient sticker for documentation purposes
(to be used by health care provider on patient file)
- 8  Prescription device
CAUTION: FEDERAL LAW RESTRICTS THE DEVICE TO SALE BY OR ON THE ORDER OF A LICENCED HEALTH CARE PROVIDER.
- 9  Product description
(translated as per international standards)

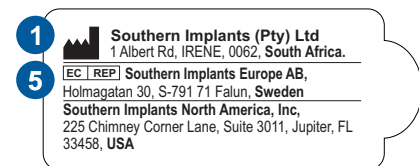
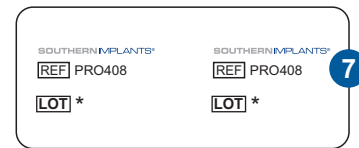
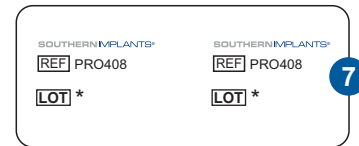
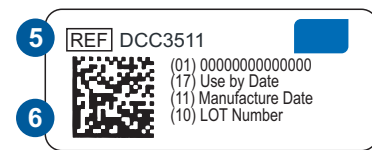
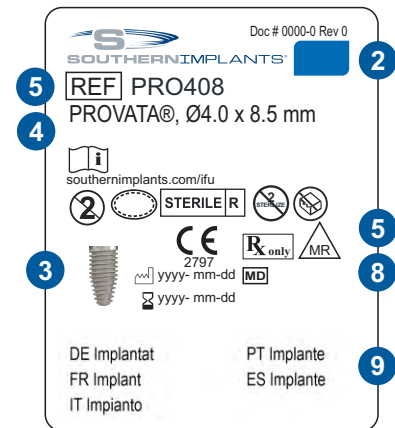

For more information on Instructions for Use of our products, please scan the below,



or visit our website southernimplants.com/ifu

For more information scan the below



to contact your Southern Implants Representative
or visit southernimplants.com



South Africa - Headquarters 1 Albert Road, Irene, RSA
T: +27-12-667-1046 | **E:** info@southernimplants.com



Southern Implants Europe AB Holmgatan 30, S-791 71, Falun, Sweden
E: ecrep@southernimplants.com

Subsidiaries

Australia

Southern Implants Australia
T: +61-2-8076-9337
E: info@southernimplants.com.au

Spain and Portugal

Southern Implants Ibérica
T: +34 935 053 507
E: info@southernimplants.es

United Kingdom and Ireland

Southern Implants UK
T: +44-20-8899-6845 / 6 / 7
E: info@southernimplants.co.uk

USA and Canada

Southern Implants North America Inc.
T: +1-561-472-0990
E: customercare@southernimplants.com

Southern Implants are distributed world-wide, please visit southernimplants.com for a list of Distributors.
For the latest and full assortment of Southern Implant® products, visit our current resources library at southernimplants.com.