



SOUTHERNIMPLANTS®

Greece

PRODUCT CATALOGUE

Price List



EXTERNAL HEX RANGE

Η σύνδεση Εξωτερικού Εξάγωνου είναι το πιο εδραιωμένο σύστημα σύνδεσης στην αγορά και η προτιμώμενη επιλογή για πολλούς κορυφαίους ιατρούς.

Πολλοί κλινικοί ιατροί παγκοσμίως εξακολουθούν να προτιμούν το Εξωτερικό Εξάγωνο για την ευκολία χρήσης, τη διαδεδομένη διαθεσιμότητα και το μακρύ ιστορικό κλινικής επιτυχίας.

Είναι επίσης γνωστό ότι "συγχωρεί" περισσότερο σε καταστάσεις αδιάλακτης τοποθέτησης ή απόκλισης εμφυτεύματος. Συνεπώς, η Southern Implants συνεχίζει να βελτιώνει την σειρά Εξωτερικού Εξάγωνου, για να παρέχει στους πιστούς υποστηρικτές της εξαιρετική αξιοπιστία μαζί με αποδεδειγμένα σύγχρονα χαρακτηριστικά.

EXTERNAL HEX CONNECTION



	ΚΩΔΙΚΟΣ	ΜΗΚΗ	
Ø3.0	IP	8.5 / 10 / 11.5 / 13 / 15	€150
Ø3.25	IBN	8.5 / 10 / 11.5 / 13 / 15 / 18	€150
	IBNT	8.5 / 10 / 11.5 / 13 / 15 / 18	€150
Ø4.0	IBS	7 / 8.5 / 10 / 11.5 / 13 / 15 / 18	€150
	IBT	6 / 8.5 / 10 / 11.5 / 13 / 15 / 18	€150
Ø5.0	BA	6 / 7 / 8.5 / 10 / 11.5 / 13 / 15 / 18	€150
	BAT	6 / 8.5 / 10 / 11.5 / 13 / 15 / 18	€150
Ø6.0	BBBS	7 / 8.5 / 10 / 11.5 / 13 / 15	€150
	BBBT	8.5 / 10 / 11.5 / 13 / 15 / 18	€150

EXTERNAL HEX CONNECTION, Co-Axis



	ΚΩΔΙΚΟΣ	ΜΗΚΗ	
Ø3.25	IBNT12d	8.5 / 10 / 11.5 / 13 / 15 / 18	€188
Ø4.0	IBT12d	8.5 / 10 / 11.5 / 13 / 15 / 18	€188
	IBT24d	8.5 / 10 / 11.5 / 13 / 15 / 18	€188
Ø5.0	BAT12d	7 / 8.5 / 10 / 11.5 / 13 / 15 / 18	€188
	BAT24d	8.5 / 10 / 11.5 / 13 / 15 / 18	€188
	BAT36d	8.5 / 10 / 11.5 / 13 / 15 / 18	€188
Ø6.0	BBBT12d	10 / 11.5 / 13 / 15 / 18	€188
	BBBT24d	10 / 11.5 / 13 / 15	€188

EXTERNAL HEX CONNECTION, MAX



	ΚΩΔΙΚΟΣ	ΜΗΚΗ	
Ø6.0	MAX-6	6 / 7 / 9 / 11	€195
Ø7.0	MAX-7	7 / 9 / 11	€195
Ø8.0	MAX-8	7 / 9 / 11	€195
Ø9.0	MAX-9	7 / 9 / 11	€195

Prosthetic Flowchart Ø4.0 Interface

Direct

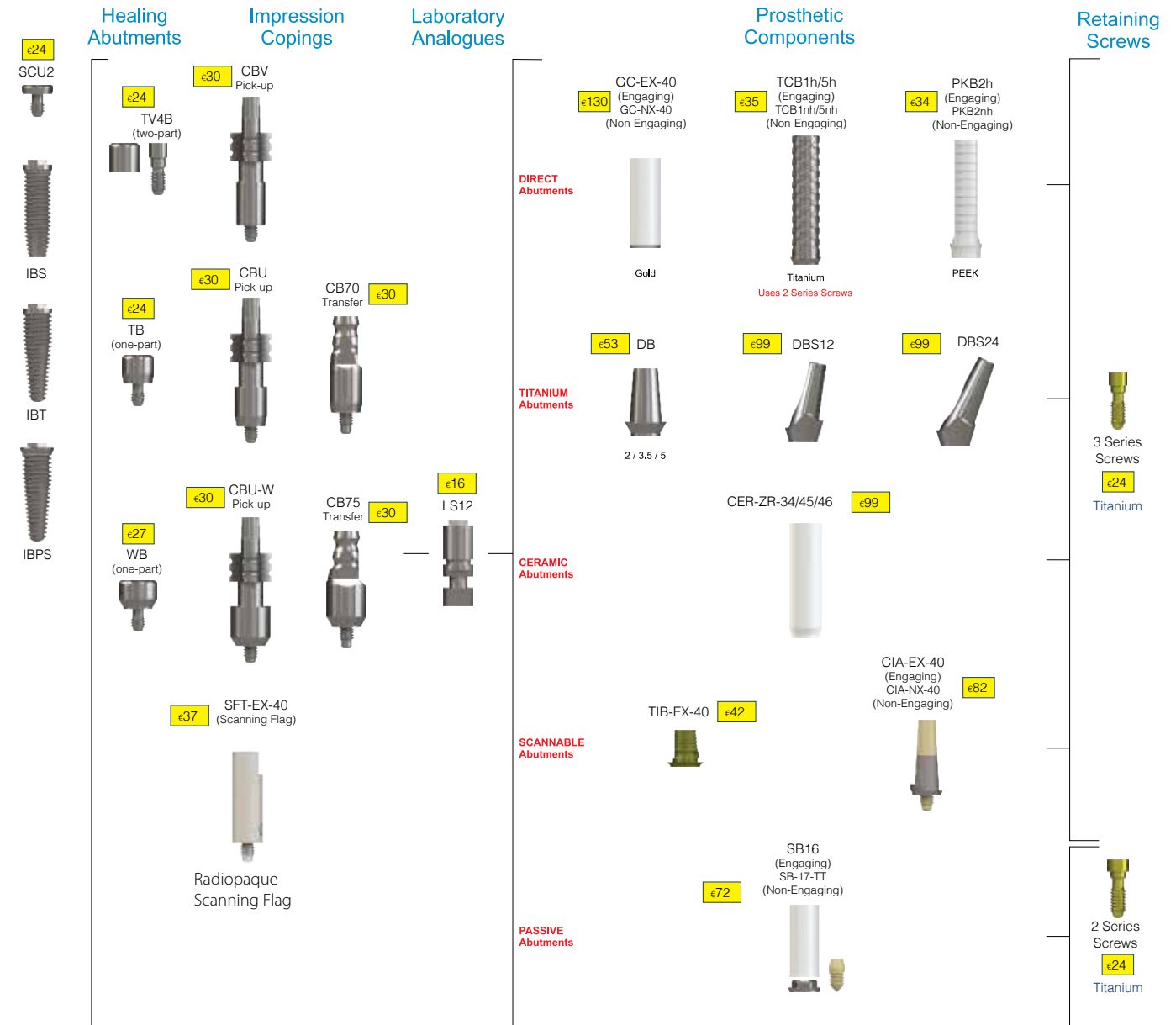

Indirect

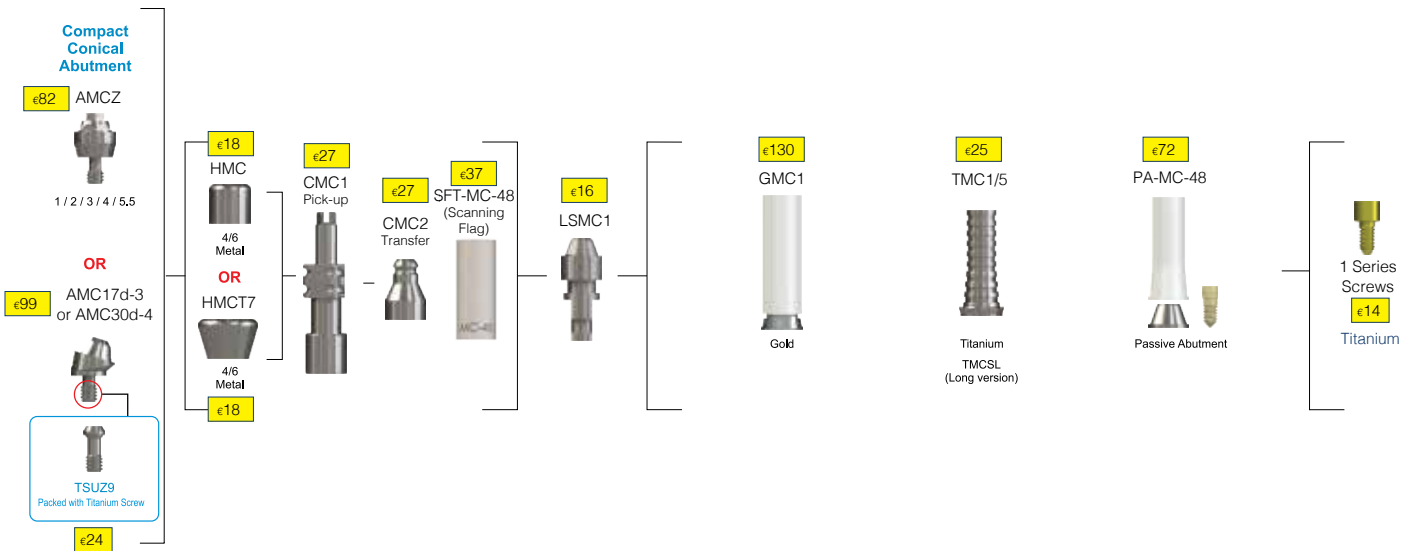

Direct

Implants

Scanning
Flag

Digital
Analogue

Prosthetic
Components

Software
Selection

Retaining
Screws

EXTERNAL HEX CONNECTION



8.5 / 10 / 11.5 / 13 / 15 / 18



TIB Abutments

TIB-EX-40
TIB-EX-40-C1.5
TIB-EX-40-C3

Engaging
Engaging
Engaging

TIB-NX-40
TIB-NX-40-C1.5
TIB-NX-40-C3

Non-Engaging
Non-Engaging
Non-Engaging

Main Selection
SI TIB EXT-HEX

Secondary Selection
TIB-EX-40 EN
TIB-EX-40-C1.5 EN
TIB-EX-40-C3 EN

TIB-NX-40 NE
TIB-NX-40-C1.5 NE
TIB-NX-40-C3 NE



3 Series
Screws



Titanium



CIA Abutments

CIA-EX-40
CIA-NX-40

Engaging
Non-Engaging

Main Selection
SI CIA EXT-HEX

Secondary Selection
CIA-EX-40 EN
CIA-NX-40 NE



PASSIVE Abutment

SB16
SB-17-TT

Engaging
Non-Engaging

Main Selection
SI PASSIVE EXT-HEX

Secondary Selection
SB16 EN
SB-17-TT NE



2 Series
Screws



Titanium

Indirect

Compact Conical Abutment



AMCZ

1 / 2 / 3 / 4 / 5.5

OR

AMC17d-3
or AMC30d-4



AMC17d-3
or AMC30d-4



TSUZ9

Packed with Titanium Screw
Optional Gold Screw available

€24



PASSIVE Abutment (Compact Conical)

PA-MC-48

Non-Engaging

Main Selection
SI PASSIVE
COMPACT CONICAL

Secondary Selection
PA-MC-48 NE



1 Series
Screws



Titanium

TRI-NEX RANGE

Εσωτερική τριλοβική προσθετική σύνδεση.

Τα εμφυτεύματα διαθέτουν εσωτερικό εξάγωνο κάτω από τη τριλοβική σύνδεση, επιτρέποντας μεγαλύτερη ροπή εισαγωγής και ελαχιστοποιώντας τον κίνδυνο παραμόρφωσης της επιφάνειας εμφύτευσης.

TRI-NEX CONNECTION



	ΚΩΔΙΚΟΣ	ΜΗΚΗ	
Ø3.5	IA-LH-35	8 / 10 / 11.5 / 13 / 16	€150
Ø4.3	IA-LH-43	8 / 10 / 11.5 / 13 / 16	€150
Ø5.0	IA-LH-50	8 / 10 / 11.5 / 13 / 16	€150
Ø6.0	IA-LH-60	8 / 10 / 11.5 / 13 / 16	€150

TRI-NEX CONNECTION, Co-Axis



	ΚΩΔΙΚΟΣ	ΜΗΚΗ	
Ø4.3	IA43-12d	10 / 11.5 / 13 / 16	€188
Ø5.0	IA50-12d	10 / 11.5 / 13 / 16	€188

TRI-NEX CONNECTION, Tri-MAX



	ΚΩΔΙΚΟΣ	ΜΗΚΗ	
Ø7.0	TRI-MAX-7	7 / 9 / 11	€195
Ø8.0	TRI-MAX-8	7 / 9 / 11	€195
Ø9.0	TRI-MAX-9	7 / 9 / 11	€195

Prosthetic Flowchart Ø3.5 Interface

Direct

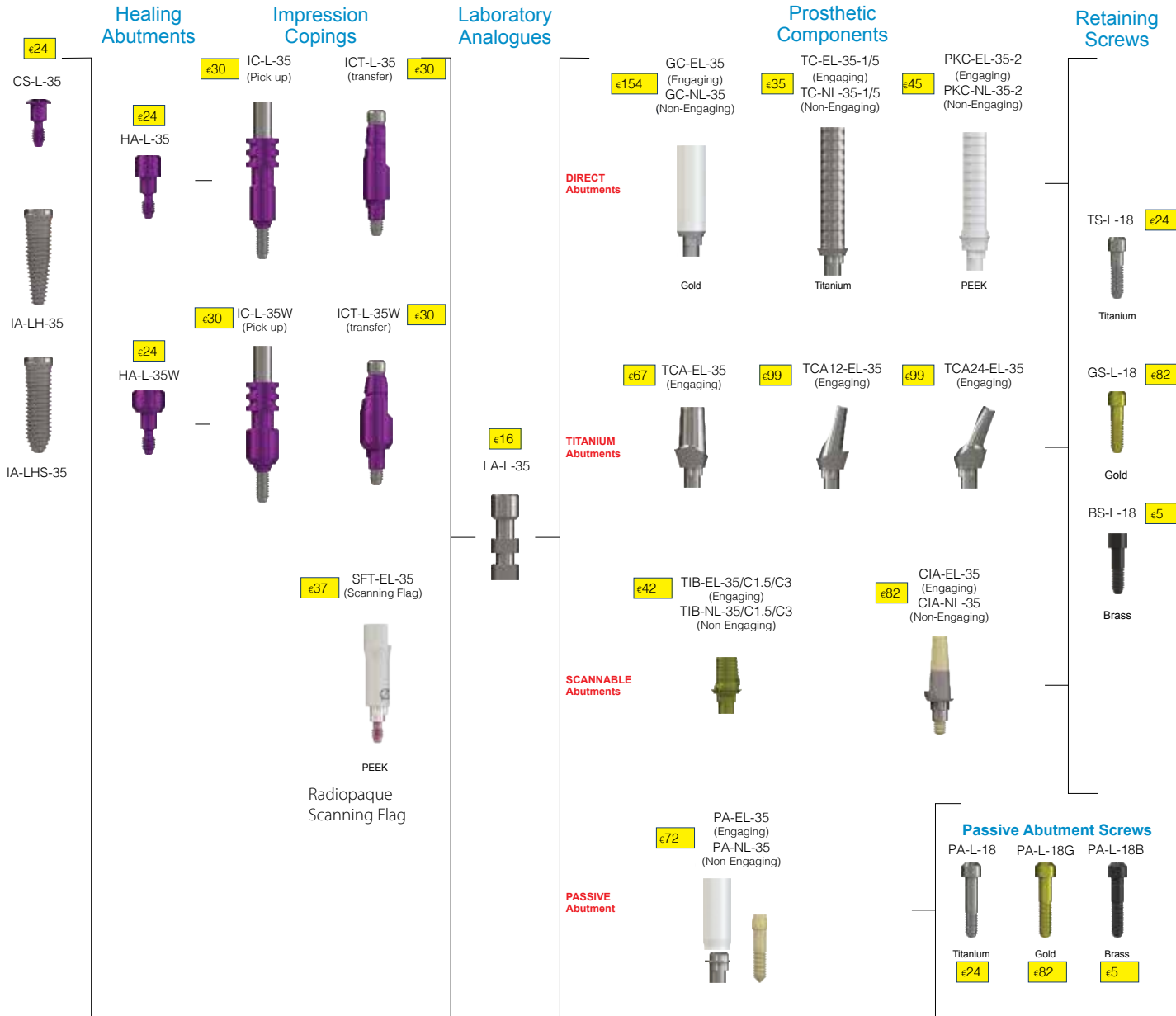



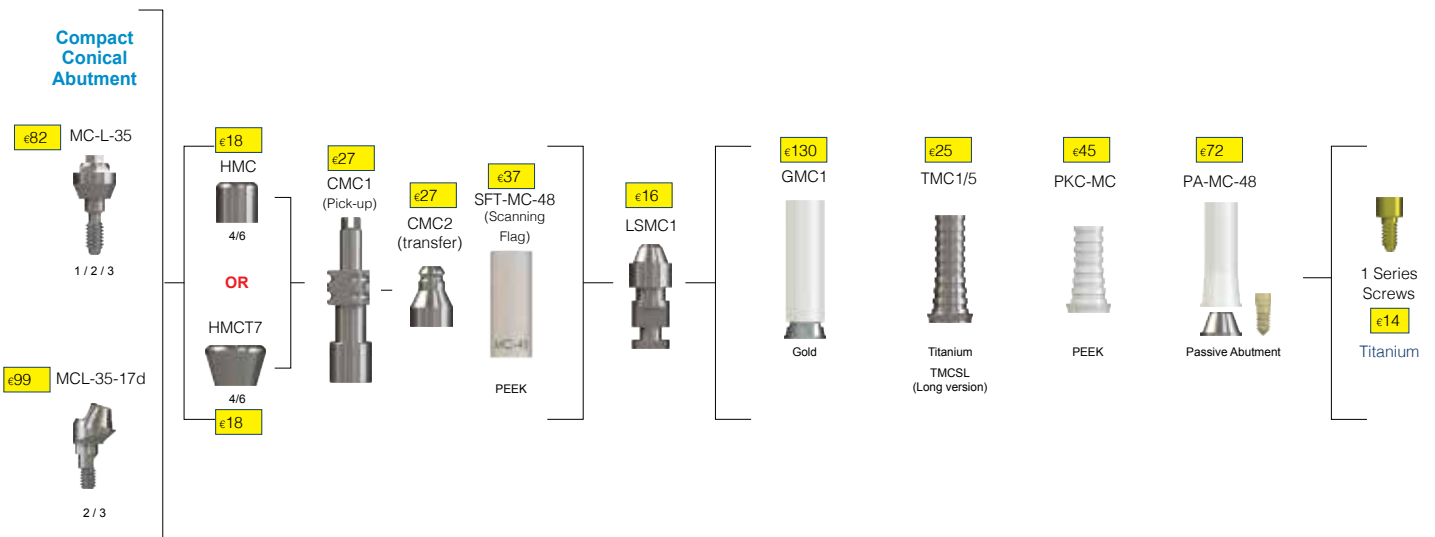



Indirect



Direct

Implants	Scanning Flag	Digital Analogues	Prosthetic Components	Software Selection	Retaining Screws
TRI-NEX CONNECTION					
 <p>8.5 / 10 / 11.5 / 13 / 15 / 18</p>	<p>€37</p> <p>SFT-EL-35</p> 	<p>€42</p> <p>LAD-L-35</p> 	<p>TIB Abutments</p> <p>€42</p> <p>TIB-EL-35 TIB-EL-35-C1.5 TIB-EL-35-C3</p> <p>Engaging Engaging Engaging</p> <p>TIB-NL-35 TIB-NL-35-C1.5 TIB-NL-35-C3</p> <p>Non-Engaging Non-Engaging Non-Engaging</p> <p>CIA Abutments</p> <p>€82</p>  <p>CIA-EL-35 CIA-NL-35</p> <p>Engaging Non-Engaging</p> <p>PASSIVE Abutment</p> <p>€72</p>  <p>PA-EL-35 PA-NL-35</p> <p>Engaging Non-Engaging</p>	<p>Main Selection SI TIB TRI-NEX</p> <p>Secondary Selection TIB-EL-35 EN TIB-EL-35-C1.5 EN TIB-EL-35-C3 EN</p> <p>TIB-NL-35 NE TIB-NL-35-C1.5 NE TIB-NL-35-C3 NE</p> <p>Main Selection SI CIA TRI-NEX</p> <p>Secondary Selection CIA-EL-35 EN CIA-NL-35 NE</p> <p>Main Selection SI PASSIVE TRI-NEX</p> <p>Secondary Selection PA-EL-35 EN PA-NL-35 NE</p>	<p>TS-L-18 €24</p> <p>Titanium</p> <p>TS-L-18C €24</p> <p>Coated</p> <p>GS-L-18 €82</p> <p>Gold</p> <p>BS-L-18 €5</p> <p>Brass</p> <p><i>*(Blackened for laboratory use only)</i></p> <p>Passive Screws</p> <p>PA-L-18 €24</p> <p>Titanium</p> <p>PA-L-18G €82</p> <p>Gold</p> <p>PA-L-18B €5</p> <p>Brass</p> <p><i>*(Blackened for laboratory use only)</i></p>

Indirect

<p>Compact Conical Abutment</p> <p>€82 MC-L-35</p>  <p>1 / 2 / 3</p> <p>OR</p> <p>€99 MCL-35-17d</p>  <p>2 / 3</p>	<p>€37</p> <p>SFT-MC-48</p> 	<p>€42</p> <p>LAD-MC</p> 	<p>€72</p> <p>PASSIVE Abutment (Compact Conical)</p> <p>PA-MC-48</p> <p>Non-Engaging</p> 	<p>Main Selection SI PASSIVE COMPACT CONICAL</p> <p>Secondary Selection PA-MC-48 NE</p>	<p>1 Series Screws €14</p> <p>Titanium</p> 
---	---	--	---	---	--

INTERNAL HEX RANGE (M-Series)

Γενική προσθετική πλατφόρμα σε όλη την γκάμα προϊόντων.

Αντίστροφη κωνικότητα στο λαιμό του εμφυτεύματος 4,2 και 5,0, για τη μείωση της πίεσης στο φλοιώδες οστό, με την τοποθέτηση και τη βοήθεια στη διατήρηση του βιολογικού πλάτους.

Εξωτερικό σπείρωμα δύο επιπέδων με μικροσυνδέσεις για την αύξηση της ταχύτητας εισαγωγής.

INTERNAL HEX CONNECTION



	ΚΩΔΙΚΟΣ	ΜΗΚΗ	
Ø3.7	IM-T37	8 / 10 / 11 / 13 / 15	€120
Ø4.2	IM-T42	8 / 10 / 11 / 13 / 15	€120
Ø5.0	IM-T50	8 / 10 / 11 / 13 / 15	€120

INTERNAL HEX CONNECTION, Co-Axis



	ΚΩΔΙΚΟΣ	ΜΗΚΗ	
Ø4.2	IM-T42xx-12d	8 / 10 / 11 / 13 / 15	€170

PROMAX



	ΚΩΔΙΚΟΣ	ΜΗΚΗ	
Ø6.0	PROMAX-6	6 / 7 / 9 / 11	€195
Ø7.0	PROMAX-7	7 / 9 / 11	€195
Ø8.0	PROMAX-8	7 / 9 / 11	€195
Ø9.0	PROMAX-9	7 / 9 / 11	€195

Prosthetic Flowchart Internal Hex Ø3.75 / Ø4.2 / Ø5.0 + Co-Axis Ø4.2 Interface (Tapered)

Direct

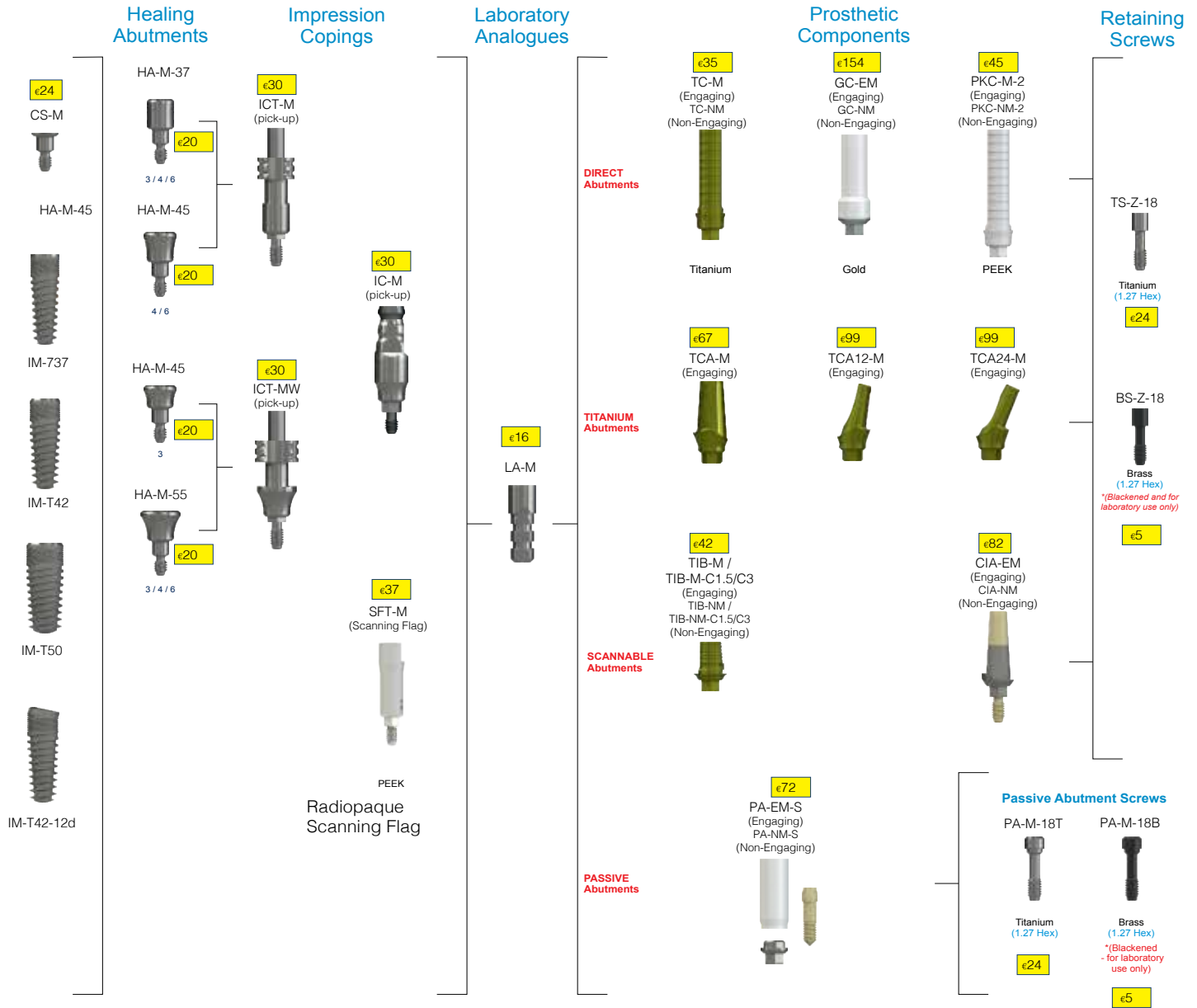

Indirect

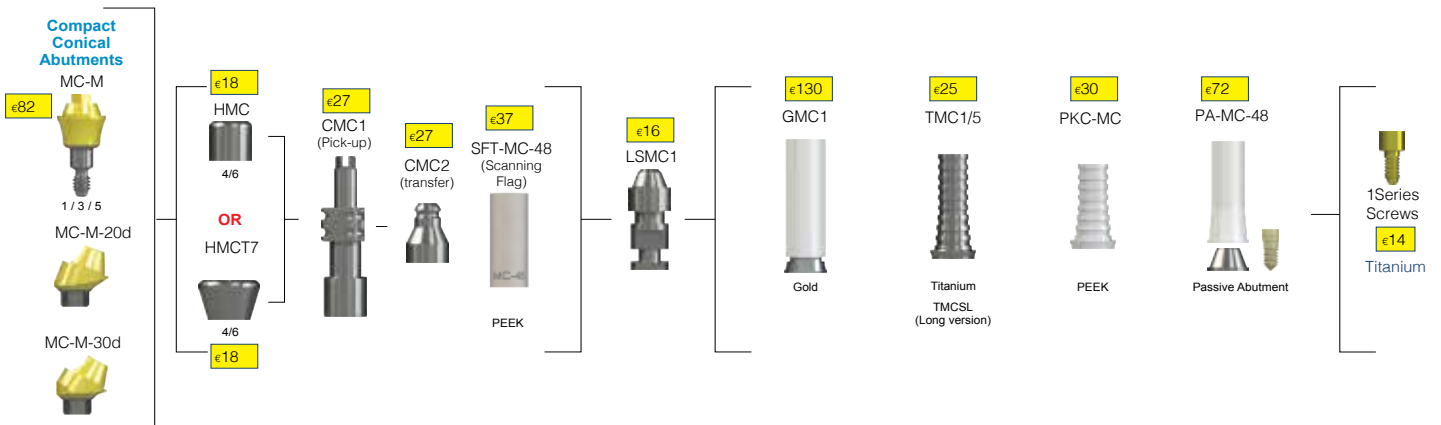

Direct

Implants

Scanning Flag

Digital Analogues

Prosthetic Components

Software Selection

Retaining Screws

INTERNAL HEX CONNECTION



8.5 / 10 / 11.5 / 13 / 15 / 18

€37



SFT-M

€42



LAD-M

€42



TIB Abutments

TIB-M
TIB-M-C1.5
TIB-M-C3

TIB-NM
TIB-NM-C1.5
TIB-NM-C3

Engaging
Engaging
Engaging

Non-Engaging
Non-Engaging
Non-Engaging

Main Selection
SI TIB INT-HEX

Secondary Selection
TIB-M EN
TIB-M-C1.5 EN
TIB-M-C3 EN

TIB-NM NE
TIB-NM-C1.5 NE
TIB-NM-C3 NE

€82



CIA Abutments

CIA-EM
CIA-NM

Engaging
Non-Engaging

Main Selection
SI CIA INT-HEX

Secondary Selection
CIA-EM EN
CIA-NM NE

€72



PASSIVE Abutment

PA-EM-S
PA-NM-S

Engaging
Non-Engaging

Main Selection
SI PASSIVE INT-HEX

Secondary Selection
PA-EM-S EN
PA-NM-S NE

TS-Z-18



€24

Titanium

GS-Q-18



€82

Gold

BS-Z-18 *



€5

Brass

**(Blacked and for laboratory use only)*

Passive Screws

PA-M-18T



€24

Titanium

PA-M-18B



€5

Brass*

Indirect

Compact Conical Abutment

€82



1 / 3

MC-M-20d



MC-M-30d



€37



SFT-MC-48

€42



LAD-MC

€72



PASSIVE Abutment (Compact Conical)

PA-MC-48

Non-Engaging

Main Selection
SI PASSIVE COMPACT CONICAL

Secondary Selection
PA-MC-48 NE



1 Series Screws

€14

Titanium

DEEP CONICAL

Το σύστημα οδοντικής εμφύτευσης Deep Conical (DC) προσφέρει στους επαγγελματίες ένα οδοντικό εμφύτευμα με υπερασύγχρονη σχεδίαση. Διατίθεται σε διαμέτρους εμφυτεύματος 3.0 mm, 3.5 mm, 4.0 mm και 5.0 mm. Κοντό ή κυλινδρικό σχήμα σώματος. Μήκος 6-15mm. Μέτρια τραχιά επιφάνεια με 15 χρόνια κλινικών στοιχείων. Διατίθεται σε διαμόρφωση Co-Axis™ διαμέτρου 3.5 mm και 4.0 mm (γωνιακή πλατφόρμα).

DEEP CONICAL CONNECTION



	ΚΩΔΙΚΟΣ	ΜΗΚΗ	
Ø3.0	DCT30xx	9 / 11 / 13	€150
Ø3.5	DCT35xx	8 / 9 / 11 / 13 / 15	€150
Ø4.0	DCT40xx	6 / 8 / 9 / 11 / 13 / 15	€150
Ø5.0	DCT50xx	9 / 11 / 13 / 15	€150

DEEP CONICAL CONNECTION, Co-Axis



	ΚΩΔΙΚΟΣ	ΜΗΚΗ	
Ø3.5	DCT35xx-12d	8 / 9 / 11 / 13 / 15	€188
Ø4.0	DCT40xx-12d	8 / 9 / 11 / 13 / 15	€188

Prosthetic Flowchart Deep Conical Ø3.0 / Ø3.5 / Ø4.0 / Ø5.0

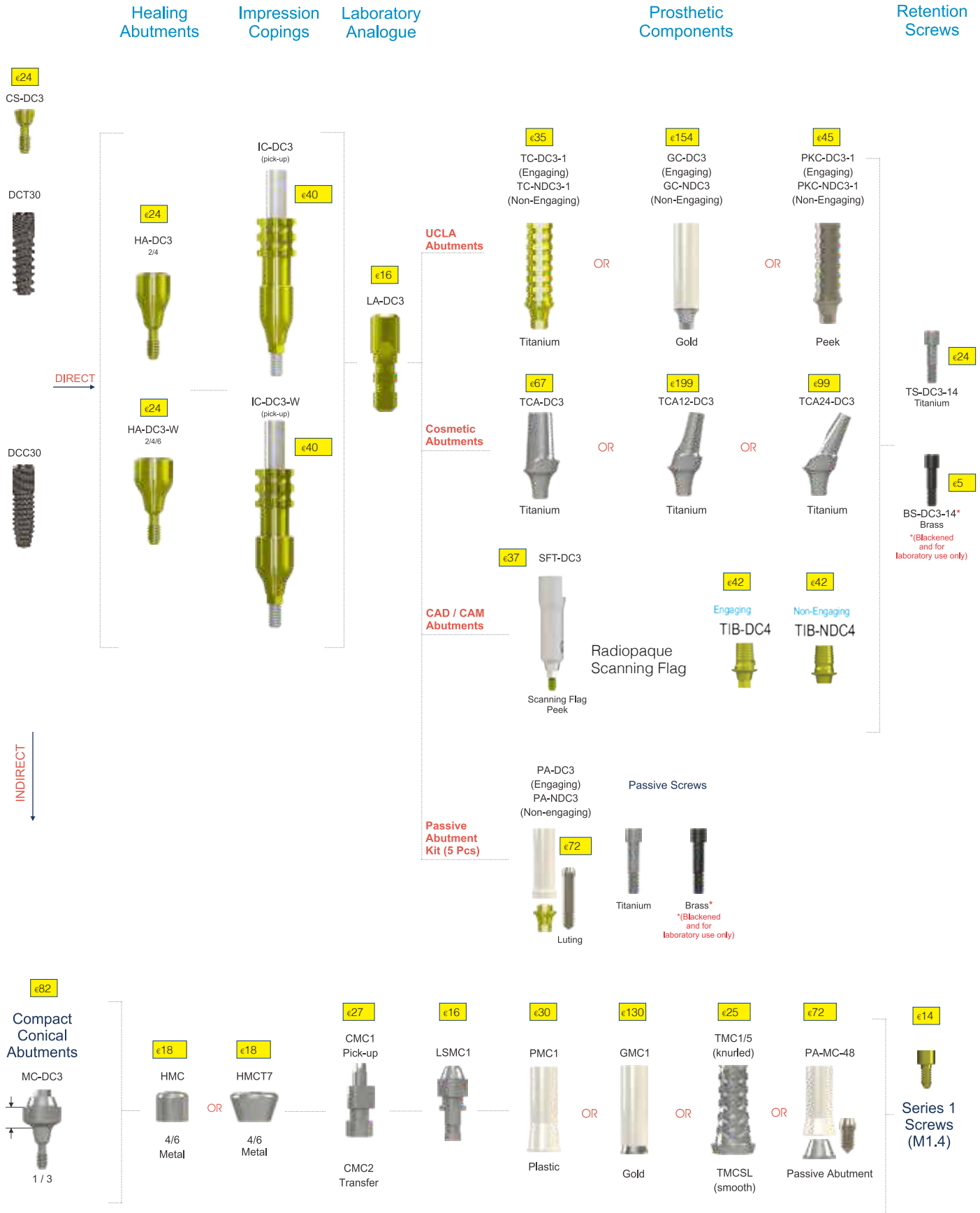

Direct

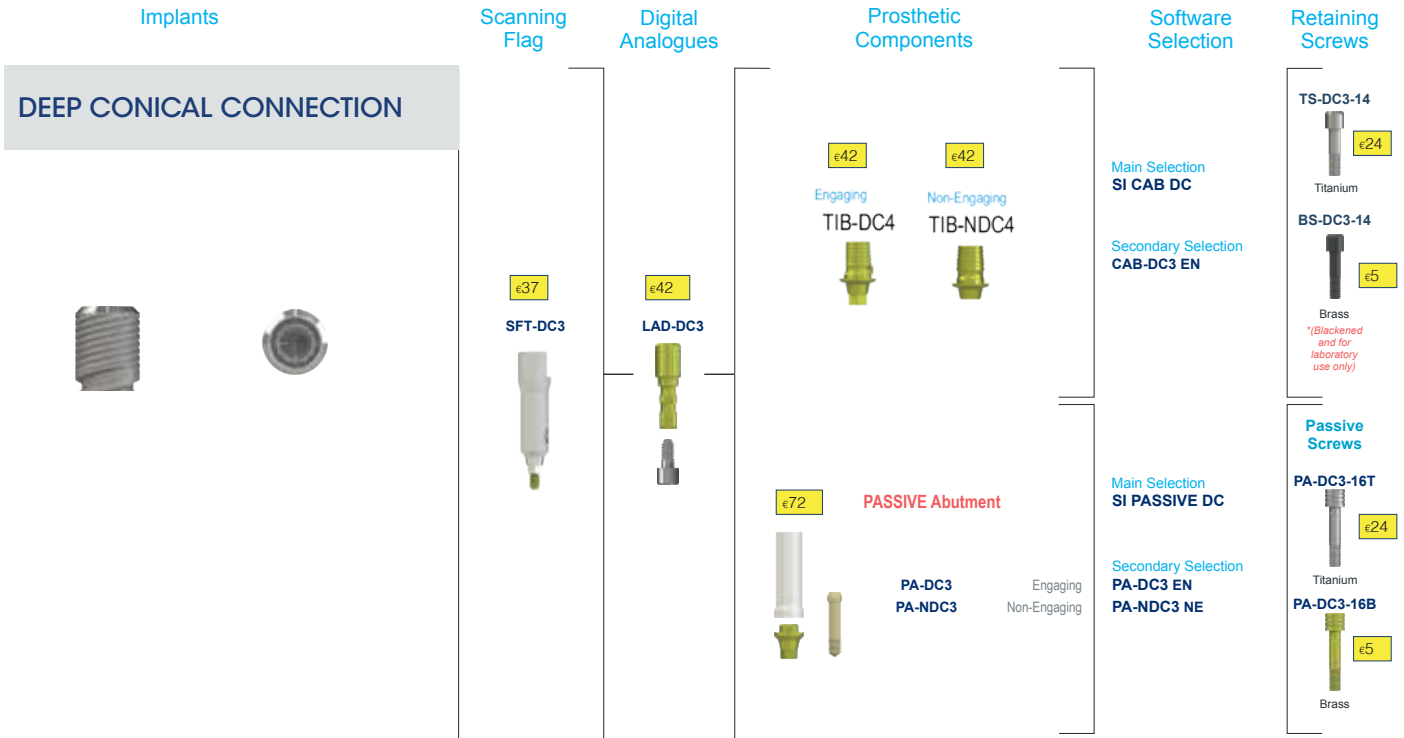

Indirect

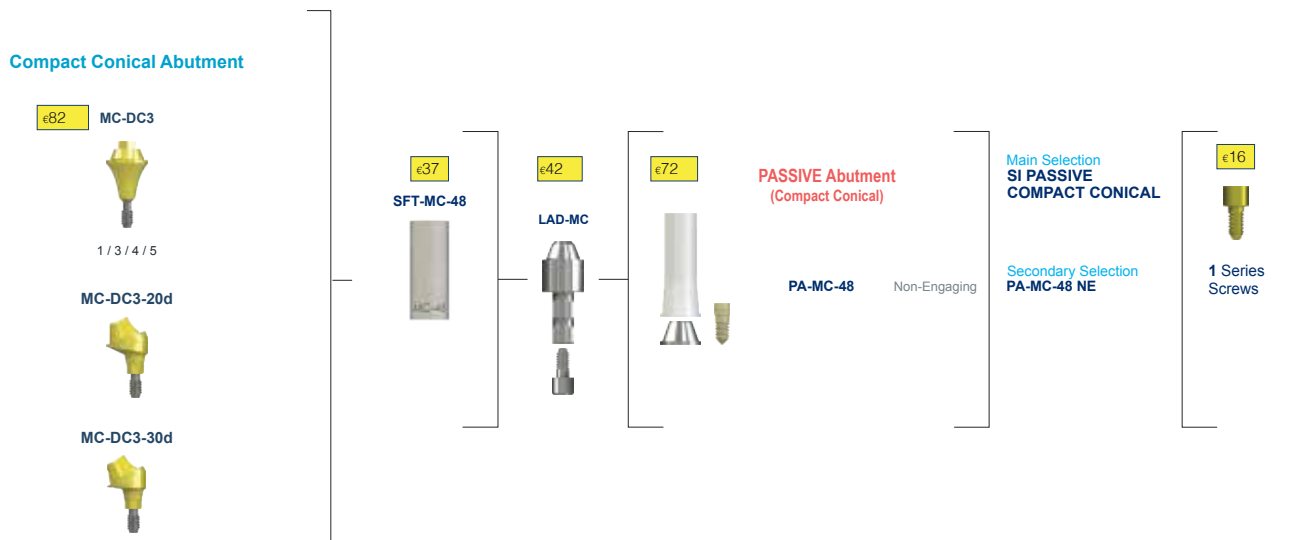

IT

Το σύστημα οδοντικής εμφύτευσης IT διατίθεται σε κυλινδρικό (ITC) και κωνικό (ITT) σχήμα σώματος.
Τα ITC διατίθενται σε διαμέτρους 3.3mm, 4.1mm και 4.9mm ενώ τα ITT σε διαμέτρους 4.0mm, 5.0mm και 6.0mm.

INTERNAL OCTAGON CONNECTION



ITT (Tapered)

ITC (Cylindrical)

	ΚΩΔΙΚΟΣ	ΜΗΚΗ	
Ø3.3	ITC	6 / 8 / 10 / 12 / 14	€150
Ø4.1	ITC	6 / 8 / 10 / 12 / 14	€150
Ø4.9	ITC	6 / 8 / 10 / 12	€150
Ø4.0	ITT	8 / 10 / 12 / 14	€150
Ø5.0	ITT	8 / 10 / 12 / 14	€150
Ø6.0	ITT	8 / 10 / 12 / 14	€150

INTERNAL OCTAGON CONNECTION, Co-Axis



	ΚΩΔΙΚΟΣ	ΜΗΚΗ	
Ø4.0	ITST12d	8 / 10 / 12 / 14	€188
Ø5.0	ITST12d	8 / 10 / 12 / 14	€188

INTERNAL OCTAGON CONNECTION, MAXIT



	ΚΩΔΙΚΟΣ	ΜΗΚΗ	
Ø7.0	MAXIT7	7 / 9 / 11	€195

Prosthetic Flowchart Internal Octagon Ø3.3 / Ø4.0 / Ø4.1 / Ø4.9 / Ø5.0 / Ø6.0 / Ø7.0

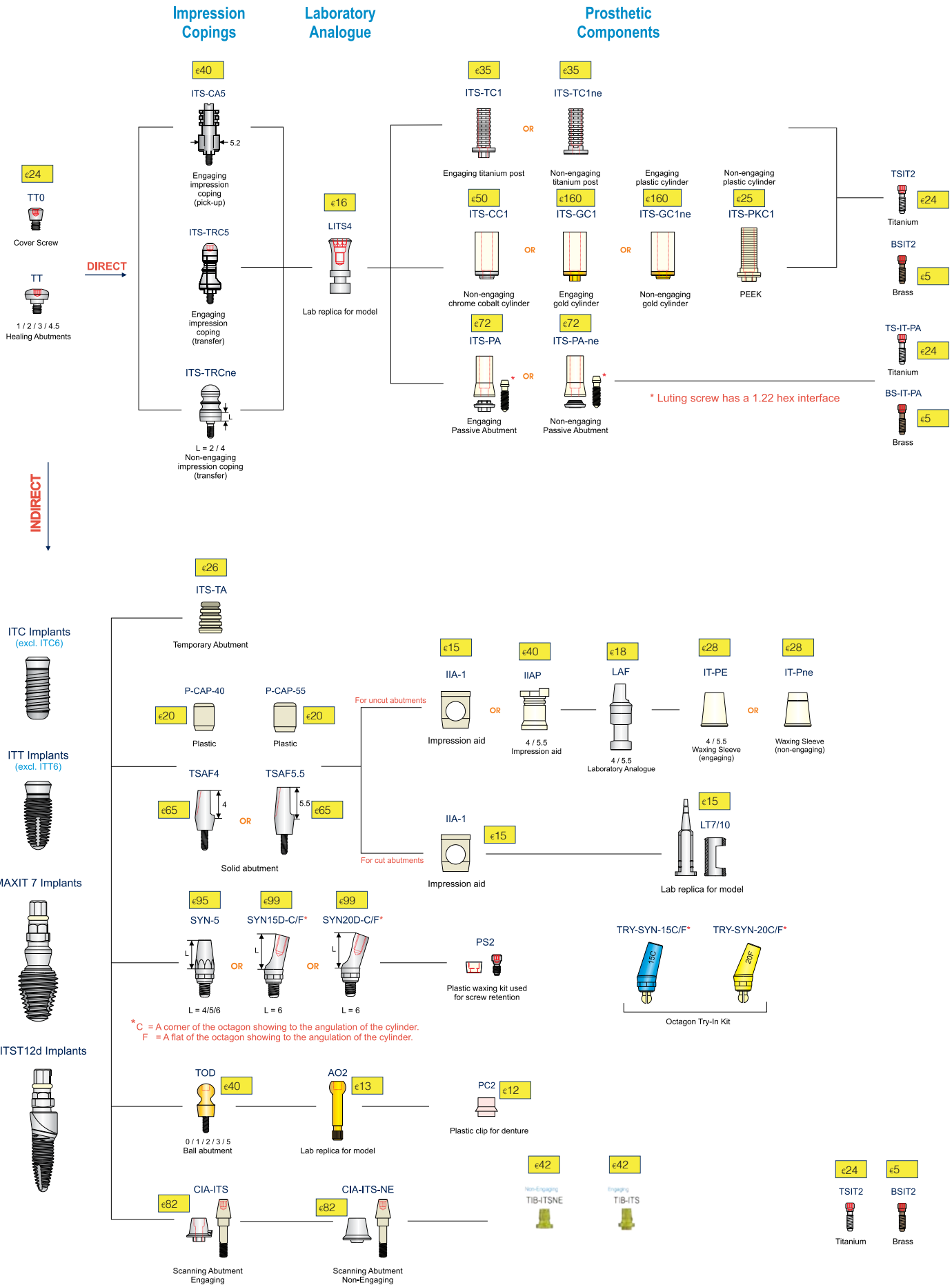

CAD/CAM Workflow (Exocad, 3Shape, Dental Wings)

Direct

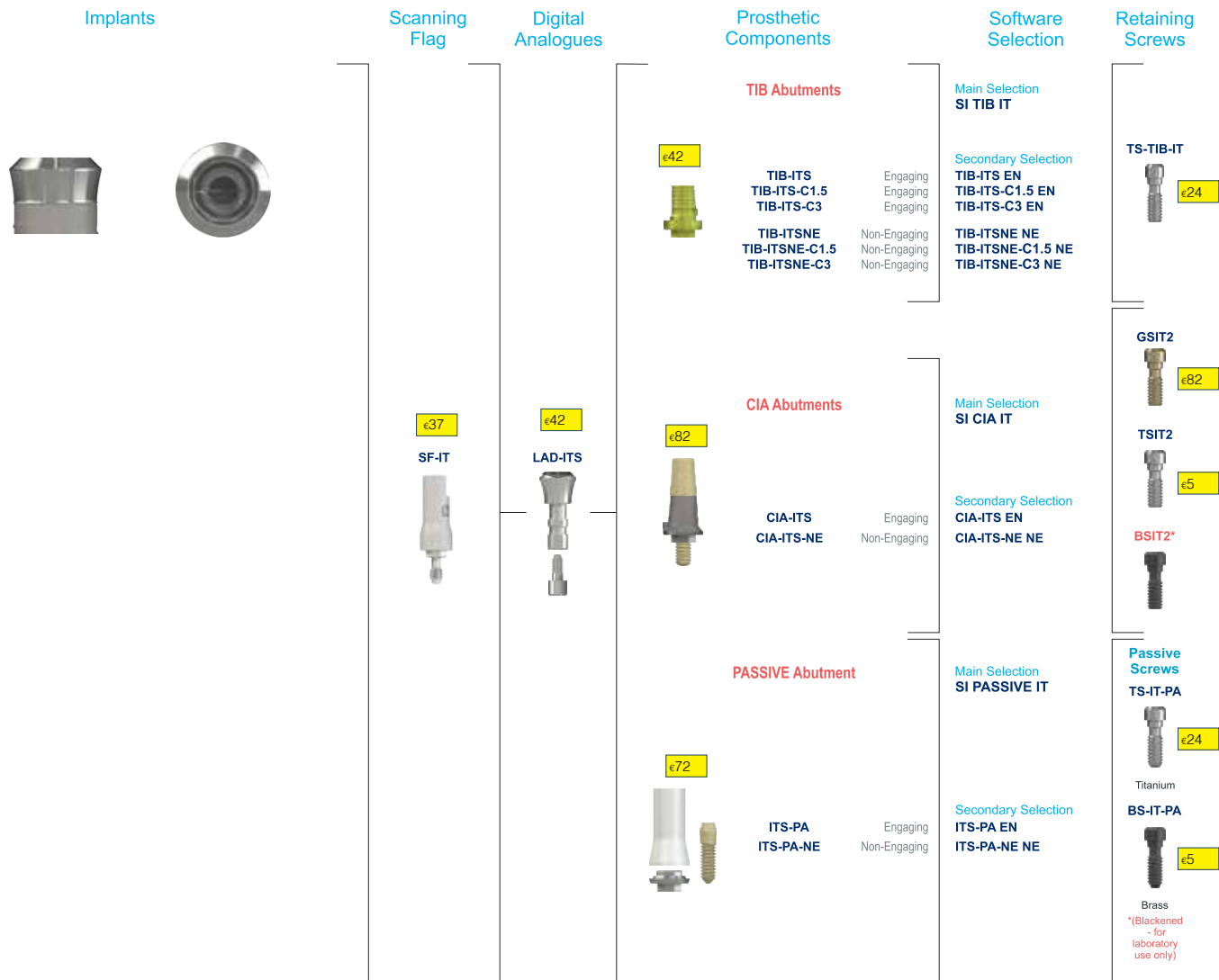

CAD/CAM Workflow (Sirona)

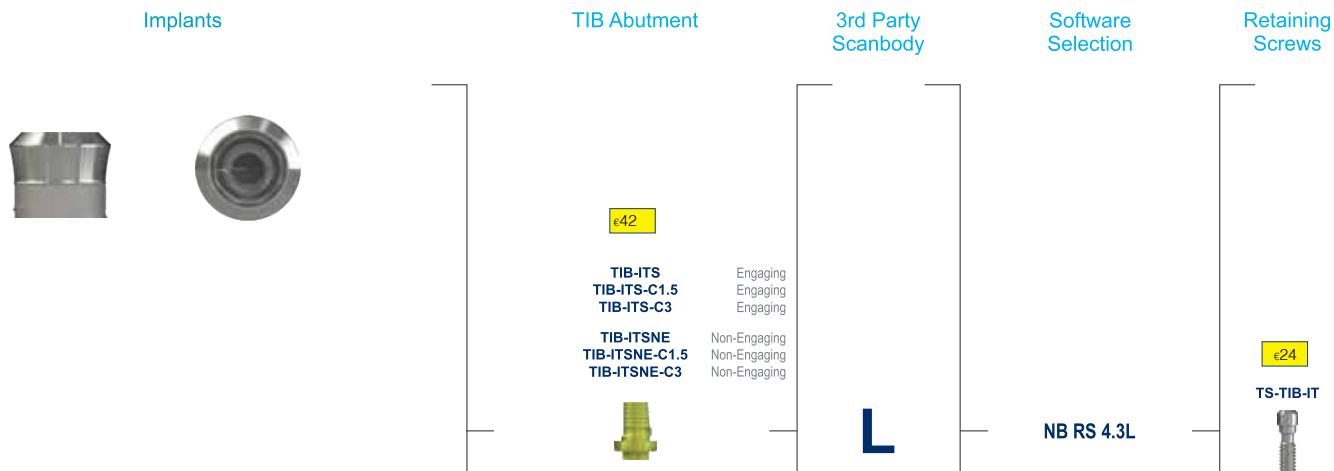



OSSEOINTEGRATED FIXTURES

Τα εμφυτεύματα Zygomatic και Oncology, είναι βελτιστοποιημένα για προσθετική ευελιξία.

Τα Ultra-Short tapered είναι εξαιρετικά μικρά κωνικά εμφυτεύματα, για αυξημένη αρχική σταθερότητα.

Τα Ultra Short Straight implant IE & IET είναι ιδανικά για να τοποθετηθούν στο λεπτό φλοιώδες οστό που βρίσκεται στις περιοχές κρανίου-προσώπου.

ZYGOMATIC & ONCOLOGY



	ΚΩΔΙΚΟΣ	ΜΗΚΗ	
Ø4.0	ZYG-55	35N / 37.5N / 40N / 42.5N / 45N / 47.5N / 50N / 52.5N / 55N / 60N	€375
Ø4.0	ZYGAN	35 / 37.5 / 40 / 42.5 / 45 / 47.5 / 50 / 52.5 / 55 / 60	€375
Ø4.0	ONC-55	27.5N / 32.5N / 37.5N / 42.5N / 47.5N	€375

Prosthetic Flowchart Zygomatic, Oncology, Zygan & Zygex

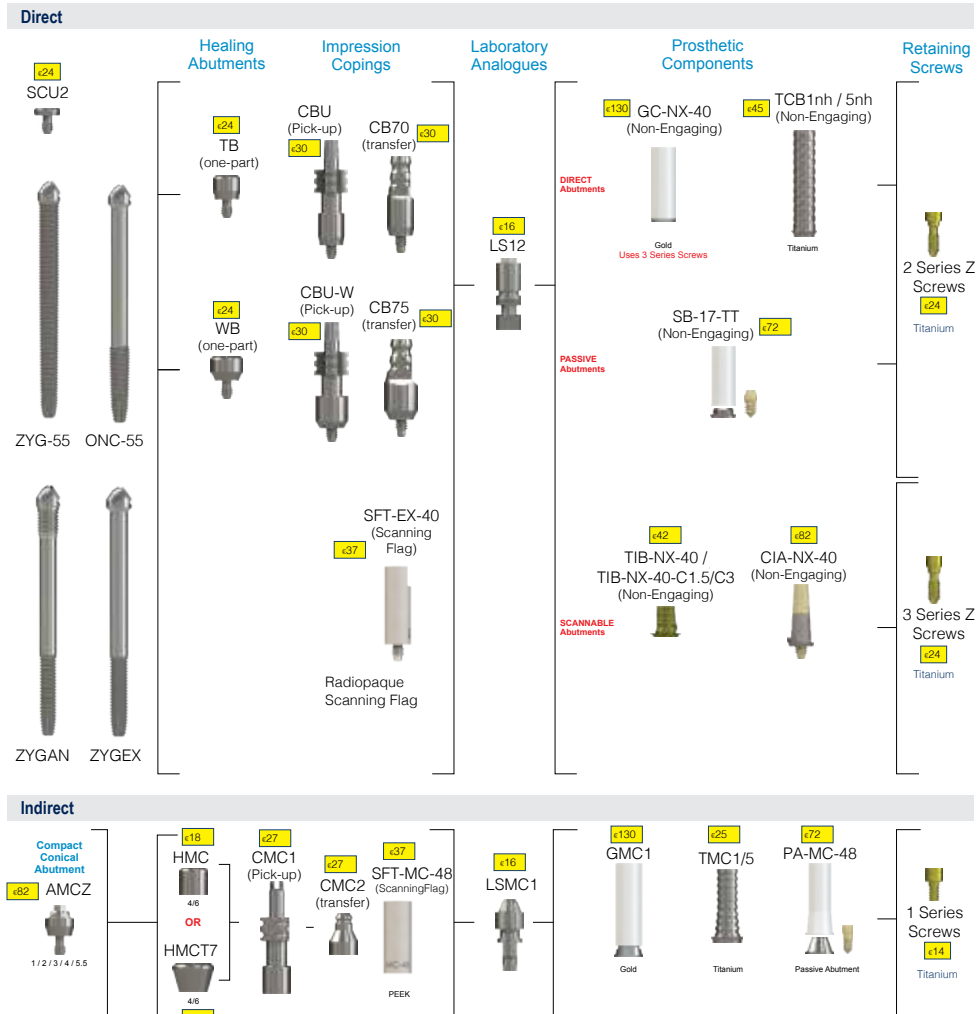

ULTRA SHORT & SHORT IMPLANTS

ULTRA SHORT & SHORT



	ΚΩΔΙΚΟΣ	ΜΗΚΗ	
Ø4.0	IET	3 / 4 / 6	€170
Ø4.0	IET / IETi	4	€170

Prosthetic Flowchart External Hex Ultra Short Ø3.75 / Ø4.5 interface

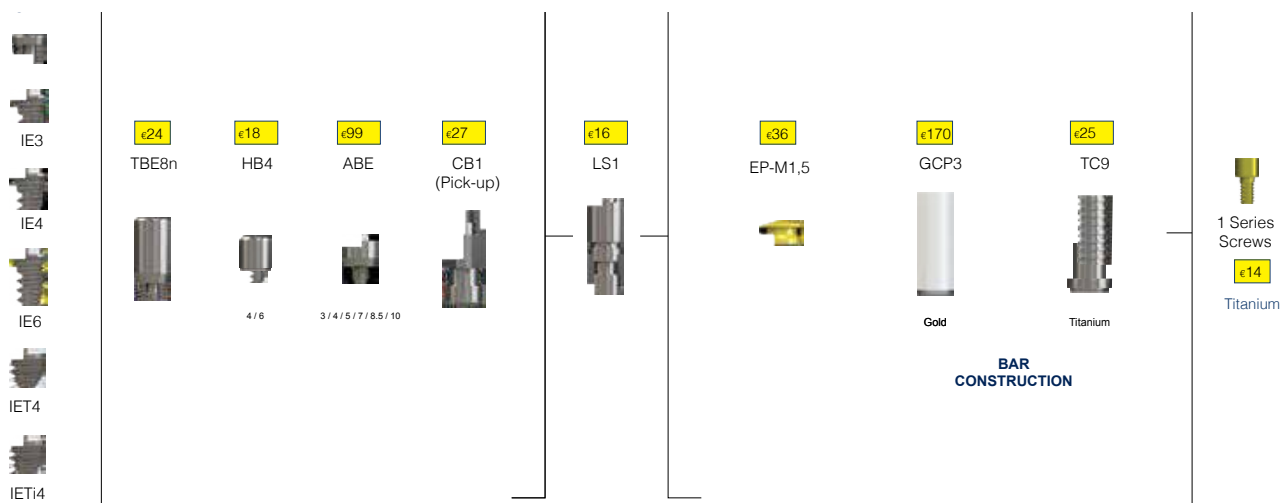

DRIVER INFORMATION

Κατσαβίδια με κοντή και μακριά λαβή για βίδες (Slot, Hex, Quad / Square)
Κατσαβίδια χειρολαβής και κασάνια για βίδες (Slot, Hex, Quad / Square)

	Χεριού € 50	Χειρολαβής € 32	Κασάνιας € 34
			



	1,22 0.9	I-HD-S/M/L I-CS-HD/L	I-HHD-22S/M/L I-HHD-09	I-WI-22S/M/L I-WI-09
HEX				
SLOTTED		I-BD-S/M/L	I-HBDS-S/M/L	I-WI-BS/M/L
UNIGRIP		I-UGI-S/M/L	I-HUG-S/M/L	I-WI-UG-S/M/L
QUAD		I-QDI-S/M/L	I-HQD-S/M/L	I-WI-QS/M/L
TORX		I-SCS-S/M/L	I-HSCS-S/M/L	I-WI-SCS-S/M/L

Χεριού με μακριά λαβή	€ 50	
HEX	1,22 0.9	I-HD-LH I-CS-LH
SLOTTED		I-BD-LH
UNIGRIP		I-UD-LH
QUAD		I-QD-LH







ABUTMENT DRIVER INFORMATION

Κατσαβίδια με κοντή και μακριά λαβή για Abutments (Standard, Conical, Compact Conical)
 Κατσαβίδια χειρολαβής και κασάνια για Abutments (Standard, Conical, Compact Conical)

Abutment Drivers	Χεριού € 40	Χειρολαβής € 32	Κασάνιας € 34
			
	I-AD	I-HAD	I-WI-A

Χεριού με μακριά λαβή € 50 I-AD-LH 

SOUTHERN IMPLANTS SCREWS

Hexed	Unigrip	Quad	Slotted	Torx
				
Series 1 Screws (M1.4) 10-15Ncm Head Diameter 2.25mm	Series 2 & 2Z Screws (M2) 32-40Ncm Head Diameter 2.70mm	Series 3 & 3Z Screws (M2) 32-40Ncm Head Diameter 2.40mm	Series 9 & 9Z Screws (M2) 15-20Ncm Head Diameter 2.50mm Special head for use with Angled Compact Conical Abutments	



MSc EXTERNAL HEX
SOUTHERNIMPLANTS

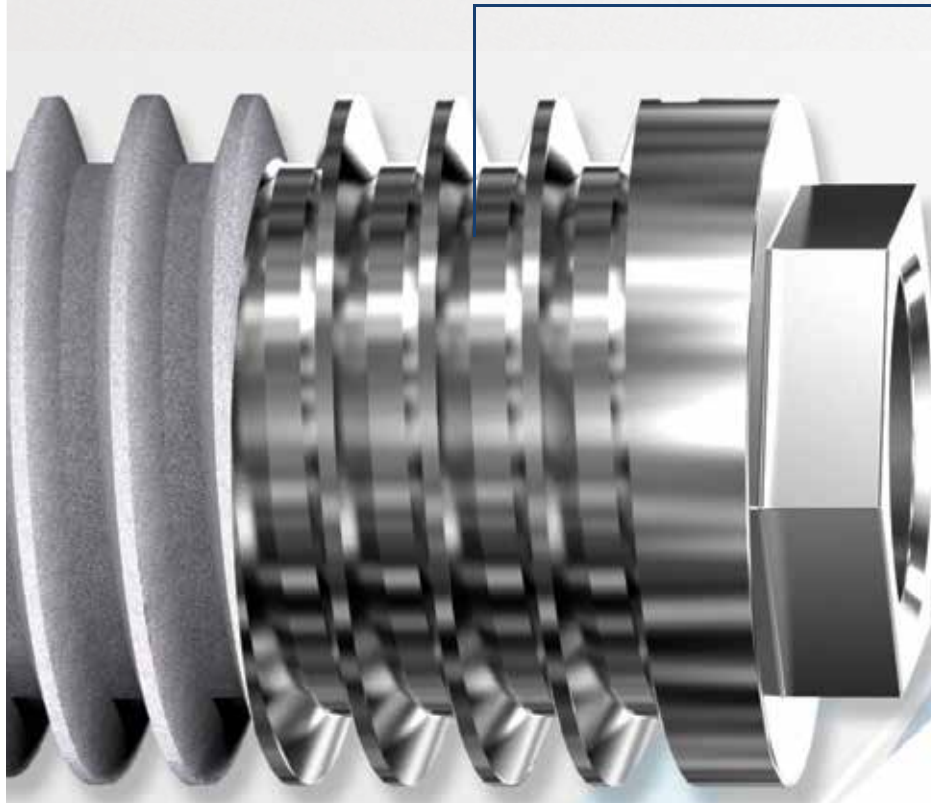

Κατεργασμένη επιφάνεια στεφάνης συγκεκριμένης τραχύτητας. Η ομαλότερη στεφαναία επιφάνεια έχει σχεδιαστεί για να μειώνει τη βακτηριακή πρόσφυση και επομένως μειώνει τον κίνδυνο μόλυνσης που μπορεί να οδηγήσει σε οριακή απώλεια οστικής μάζας.

Machined Surface Coronal (MSc)

Σημαίνει κατεργασμένη επιφάνεια.

Αποτυπώνοντας τα πλεονεκτήματα της αποδεδειγμένα σκληρής επιφάνειας της Southern, όπου χρειάζεται περισσότερο για την πρόληψη των αρχικών βλαβών, και την επιφάνεια, ειδικά κατεργασμένης τραχύτητας, για τη διατήρηση του οστού σε καταστάσεις βακτηριακής επίθεσης.

Ενδείκνυται για ασθενείς με υψηλότερο κίνδυνο στεφαναίας απώλειας οστού (καπνιστές, ιστορικό περιοδοντίτιδας, καρδιαγγειακής νόσου)

SOUTHERNIMPLANTS
Expanding Proven Concepts

southernimplants.gr
info@southernimplants.gr
T: 210 8982881-2



Florida Mall
Α. Μεταξά 33, Γλυφάδα
16674, Αθήνα

210 8982817 Τηλέφωνο
210 8982881
210 8982882
210 2241797 Fax

info@southernimplants.gr
www.southernimplants.gr
www.facebook.com/southernimplantsgr